



# Dual Action Windows

**WOOD CATALOGUE**





# CONTENTS

---

INTRODUCTION	5
AVAILABLE SOLUTIONS	7
NATURO 68	8
NATURO 68 ALU	14
NATURO 80	16
NATURO 80 ALU	22
NATURO 92	28
ESPERIA LIFE 74 ALU	34
ESPERIA LIFE 80	38
NATURO 68 HST	42
NATURO 80 HST	46
MODEL WINDOWS AND DOORS	50
WOODEN DOORS	51
MILLED PANELS	52
DOOR PANELS WOODLINE	58
DOOR PANELS EKOVI TRE	60
PANES	64
MUNTIN BARS	66
SWISSPACER ULTIMATE SPACER BARS AND FITTINGS	67
INTERIOR WOODEN WINDOWSILLS	68
DRIP CAPS AND DOOR ACCESSORIES	69
HANDLES AND PULL HANDLES	70
TOP SECTION DESIGN	71
WOOD COLOR PALETTE STANDARD	73







## TIMELESS WOODEN JOINERY

Woodwork is a proposition for those who appreciate the beauty that comes from nature. The ecological material is friendly to both humans and the natural environment.

Selected systems feature external aluminum cladding. Their function is to provide protection to the profiles and to bring their aesthetics closer to the subtle minimalism of modern architecture.

The wood used in production comes from trees designated for planned felling. We use four types:



### PINE

The most popular coniferous species used in woodwork production.



### SPRUCE

Easy-to-work wood that stains well.

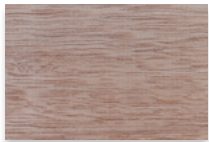

### MERANTI

Exotic wood with high moisture resistance.

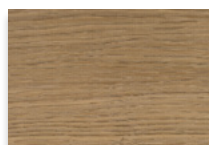

### OAK

Noble and durable wood species with high density.

*\*All types of wood are finished with colors from the stain palette or RAL palette. Additionally, clear lacquer or impregnant can be applied. Raw wood is delivered upon customer request.*

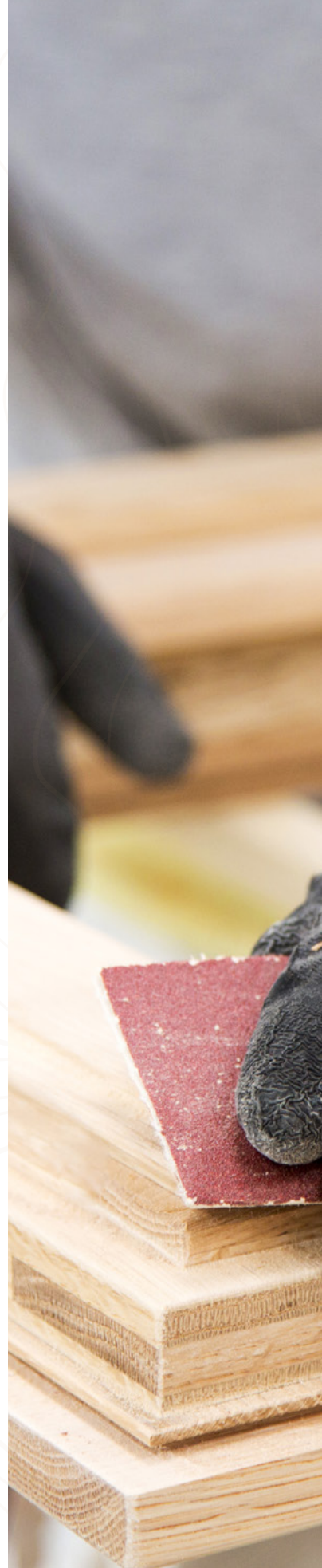



## **INDIVIDUALISM**

All wooden products are prepared according to the individual wishes of the client. This allows them to match windows and doors to their aesthetic preferences. The wealth of complementary systems translates into the ability to select solutions with the desired functional parameters. Many years of experience and specialist knowledge enable us to execute even highly unconventional projects, characterised by a unique approach to design and bold creativity.



## **VARNISHES**

The wood varnishes we use are supplied by our close collaborator, TEKNOS. This varnish manufacturer provides us with a rich palette of colours, including clear varnishes, offering a wide range of options for every client. Their coatings embody style and elegance while providing excellent protection against biological corrosion, mechanical factors, and discolouration caused by UV radiation.



## **TRANSPORT**

In order to ensure the timely and safe delivery of our products, we build custom crates for each order. We also fully handle international transport, customs, duties, fees and last mile transport to your home or job site. Orders are shipped to direct from Europe via ocean freight. We can also arrange air freight as needed.



## **ECOLOGY**

Wood is a valuable, natural resource that is also completely renewable. Its use in production helps reduce CO<sub>2</sub> emissions. We use wood from verified sources, responsibly harvested to minimize the negative impact of forestry on nature and local communities. Moreover, producing wooden windows and doors requires less energy compared to other materials. This results in lower carbon dioxide emissions during the production of joinery, as well as reduced consumption of energy resources for heating buildings, thanks to the excellent thermal properties of wood.



## AVAILABLE SOLUTIONS



### PROFILE WITH AN UNDERCUT

The standard profile with an undercut allows for the installation of a window sill or other accessories from both the outside and the inside.



### PROFILE WITHOUT AN UNDERCUT

A profile without standard undercuts means that the window sill or other accessories are mounted directly onto the frame.



### ALUMINIUM SHELLS

The profile with aluminum shells, Reno Line/ Gemini Classic, completely transforms the external appearance of windows, while also enhancing durability through additional protection of the wood against atmospheric conditions.



### RENOVATION PROFILE

A version of a profile that allows new windows to be fitted into existing buildings without the need to remove the old wooden frames. Possibility of using different lengths of the renovation fin to cover the old frame inside the building.



### MONOBLOCK PROFILE

Profile with extended installation depth. It enables the window to be fitted aesthetically in the thermal insulation layer while avoiding additional thermal bridges.



### DUTCH PROFILE

The profile features a wide and stable frame. This gives the window a distinctive appearance.



### BELGIAN PROFILE - VERSION A



### BELGIAN PROFILE - VERSION B

Belgian profiles, available in versions A and B, are made entirely of wood without additional aluminum drip caps. The versions differ in their methods of water drainage.



### OUTWARD-OPENING PROFILE

The outward-opening window design provides more interior space.



# NATURO 68

## WINDOW SYSTEMS



The following  $U_w$  value is given for a reference window with dimensions 4x6 with 4/16Ar/4one pane, wood type: pine

<b>2 11/16"</b>	<b>15/16" - 1 1/4"</b>	<b>3</b>	<b>4</b>	<b>2</b>	<b>0.21</b>
construction depth [in]	glazing units [in]	layers of glued wood	layers of varnish	gaskets	$U_w$ for $U_g = 0.18$ (the Ultimate frame)

The Naturo 68 is characterized by the smallest construction depth among our wooden systems, resulting in a sleek appearance. Windows are available in standard version as well as with aluminium shells Reno Line, which enhance their durability against mechanical factors and UV radiation while providing a modern look to the facade. Additionally, you can choose between Belgian or Dutch versions of profiles, outward-opening option, renovation or monoblock.





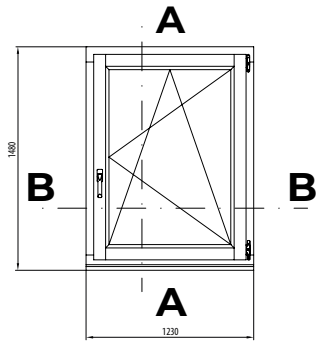

VERTICAL CROSS-SECTION A-A

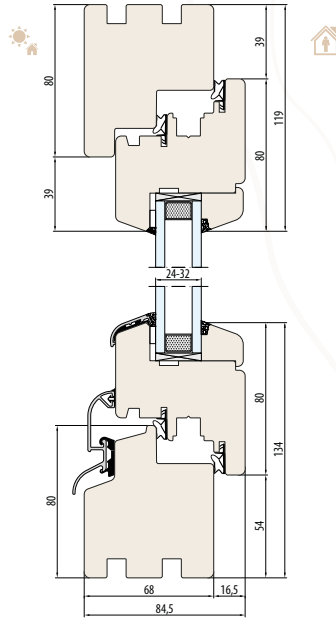

**NATURO 68 SYSTEM**  
Without undercut for the window sill

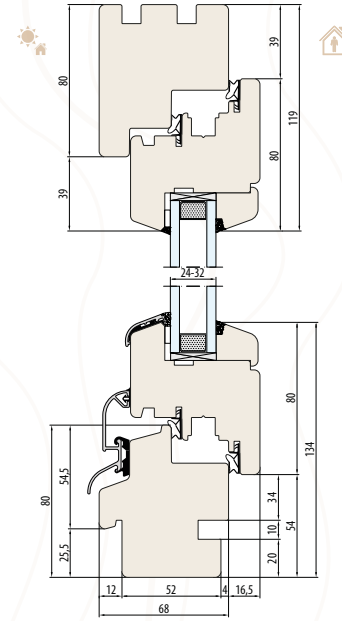

**NATURO 68 SYSTEM**  
The undercut for the interior and exterior window sill

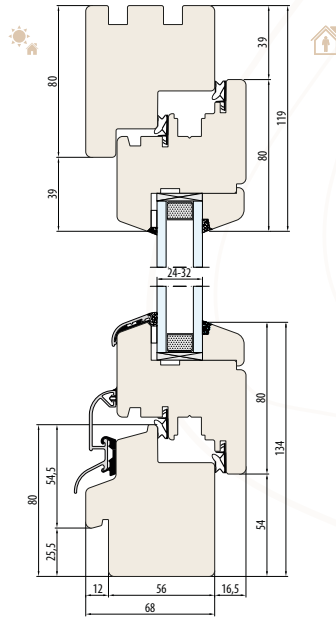

**NATURO 68 SYSTEM**  
The undercut for the exterior window sill

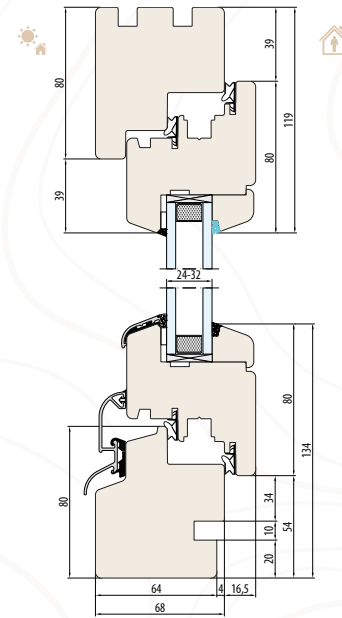

**NATURO 68 SYSTEM**  
The undercut for the interior window sill

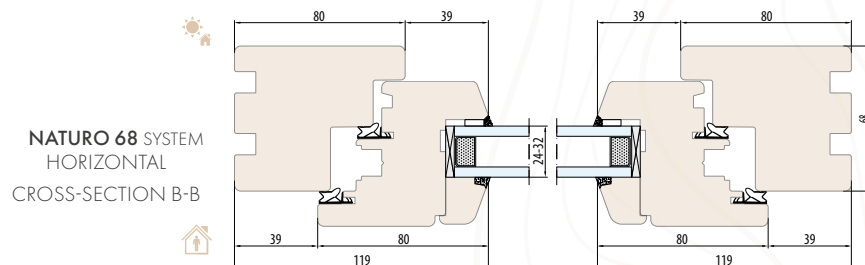

**NATURO 68 SYSTEM**  
HORIZONTAL  
CROSS-SECTION B-B

# NATURO 68

## STANDARD

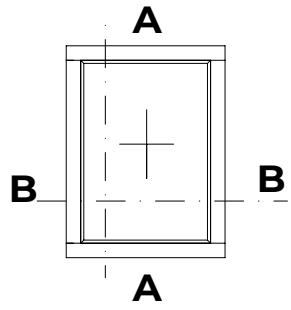

VERTICAL CROSS-SECTION A-A

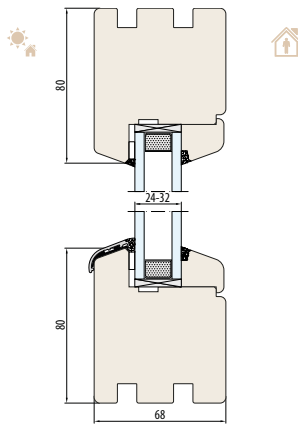

**NATURO 68 - FIX SYSTEM**  
Without undercut for the window sill

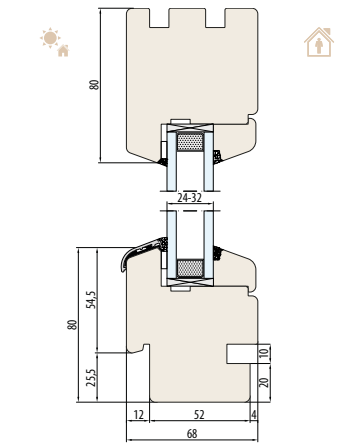

**NATURO 68 - FIX SYSTEM**  
The undercut for the interior and exterior window sill

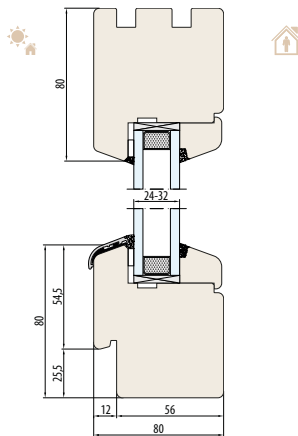

**NATURO 68 - FIX SYSTEM**  
The undercut for the exterior window sill

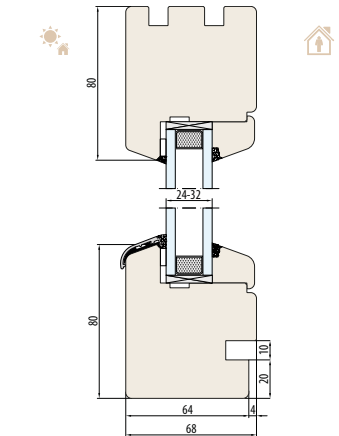

**NATURO 68 - FIX SYSTEM**  
The undercut for the interior window sill

**NATURO 68 - FIX SYSTEM**  
HORIZONTAL CROSS-SECTION B-B

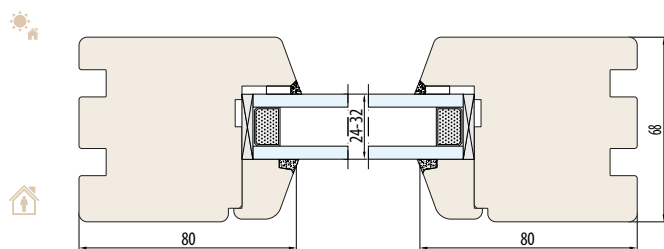

# NATURO 68

FIX



# NATURO 68

## MOVABLE POST

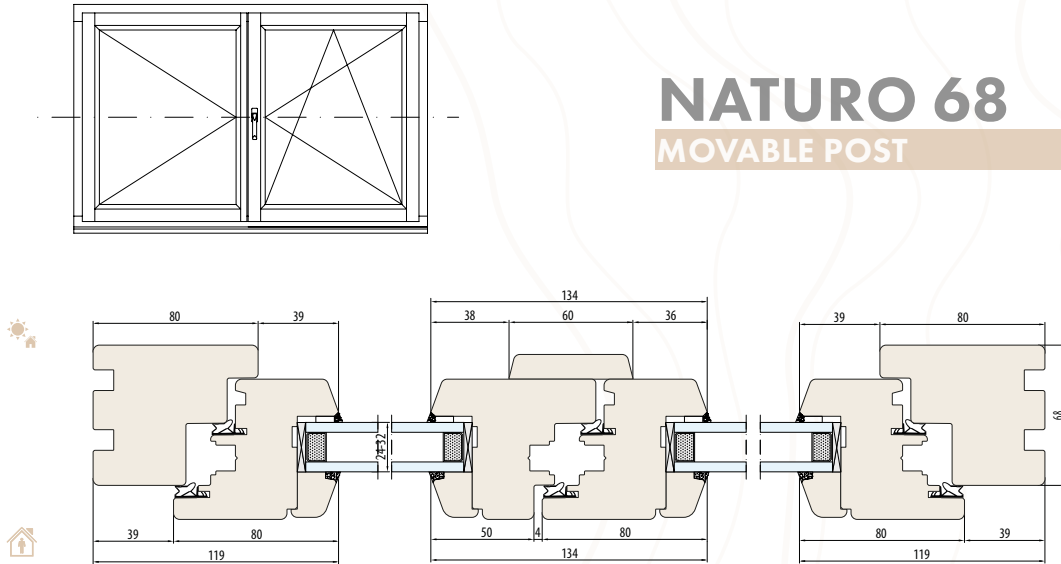

# NATURO 68

## FIXED POST

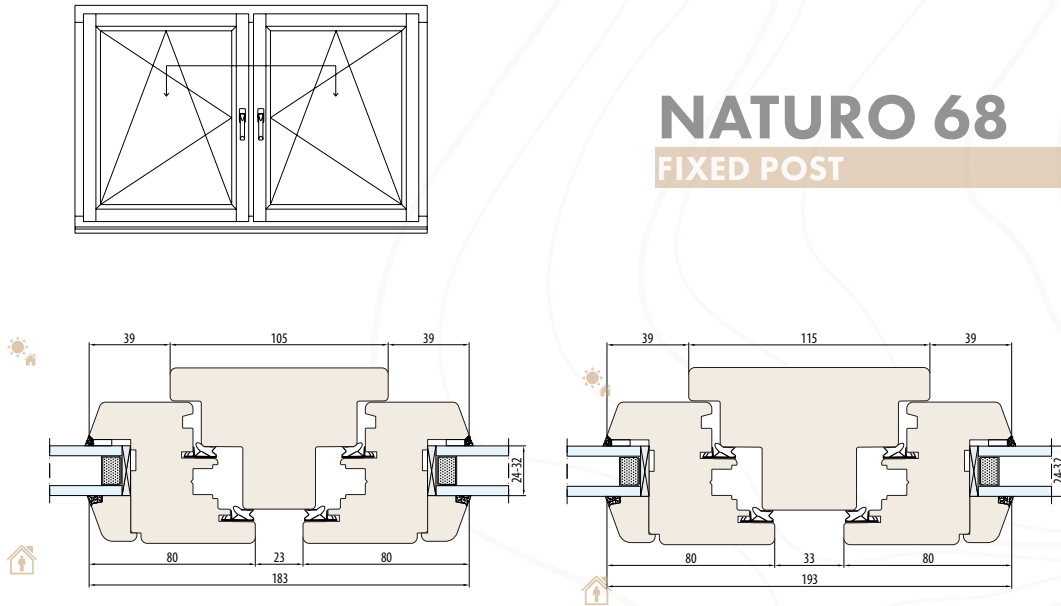

**NATURO 68 SYSTEM**  
fixed post 105 mm  
(Horizontal cross-section)

**NATURO 68 SYSTEM**  
fixed post 115 mm  
(Horizontal cross-section)

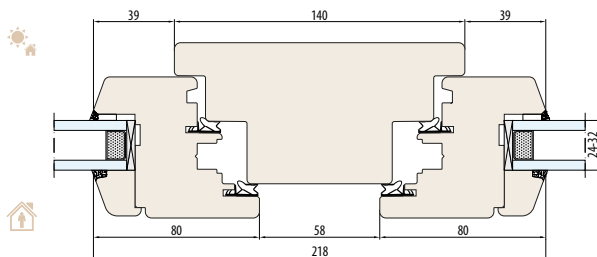

**NATURO 68 SYSTEM**  
fixed post 140 mm  
(Horizontal cross-section)

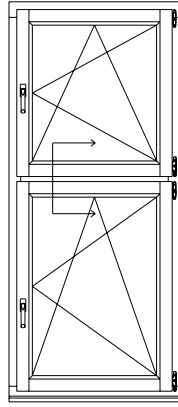

# NATURO 68

## TRANSOM BAR

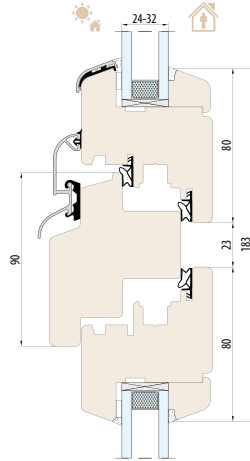

**NATURO 68 SYSTEM**  
transom bar 90 mm

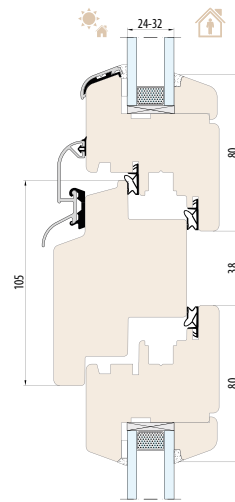

**NATURO 68 SYSTEM**  
transom bar 105 mm

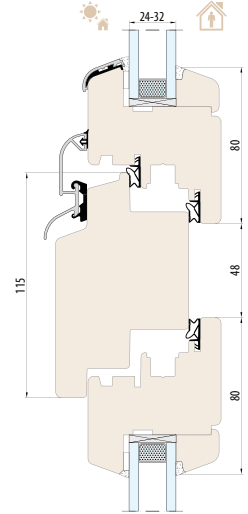

**NATURO 68 SYSTEM**  
transom bar 115 mm

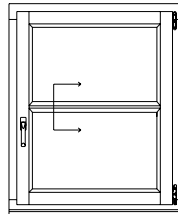

# NATURO 68

## MUNTIN BARS

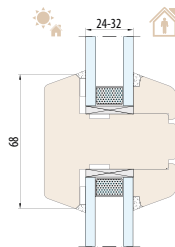

**NATURO 68 SYSTEM**  
Muntin bar 68 mm

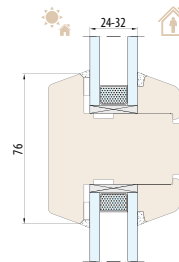

**NATURO 68 SYSTEM**  
Muntin bar 76 mm

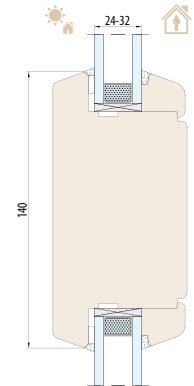

**NATURO 68 SYSTEM**  
Muntin bar 140 mm

# SPACER BARS

DEPENDENT ON THE THICKNESS OF THE GLAZING UNIT

## STANDARD GLAZING BEAD

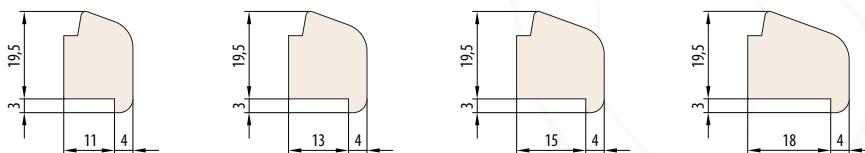

## RETRO GLAZING BEAD

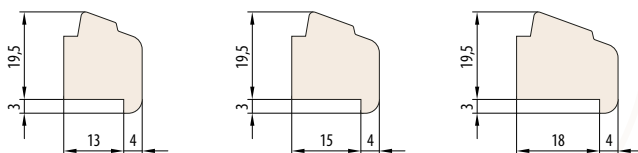

## OVERLAY GLAZING BEAD

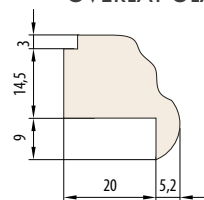





# NATURO 68 ALU

WINDOW SYSTEMS



The following  $U_w$  value is given for a reference window with dimensions 4x6 with 4/16Ar/4one pane, wood type: pine

<b>2 11/16</b>	<b>15/16" - 1 1/4"</b>	<b>3</b>	<b>4</b>	<b>2</b>	<b>0.21</b>
construction depth [in]	glazing units [in]	layers of glued wood	layers of varnish	gaskets	$U_w$ for $U_g = 0.18$ (the Ultimate frame)

The slim and elegant Naturo 68 ALU system is distinguished by aluminum covers on the exterior side of the profiles.

The presence of metal allows for a minimalist aesthetic of aluminum windows, perfectly fitting modern architectural standards



Reno Line profile  
(without an undercut)



Reno Line profile  
(with an undercut)

# NATURO 68 ALU

STANDARD

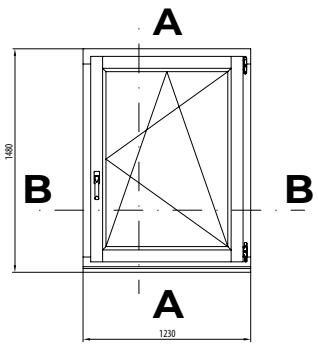

VERTICAL CROSS-SECTION A-A

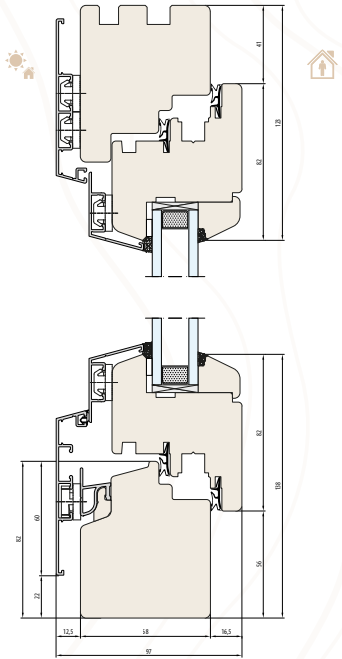

SYSTEM NATURO 68 ALU  
RENO LINE  
Without undercut for the window sill

HORIZONTAL CROSS-SECTION B-B

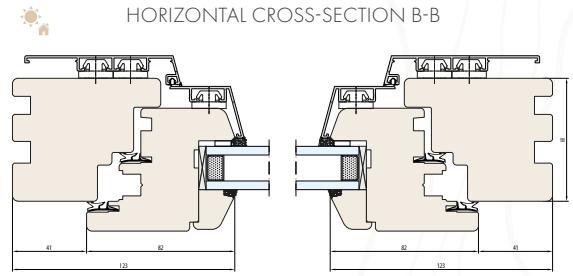

SYSTEM NATURO 68 ALU  
RENO LINE



# NATURO 80

WINDOW SYSTEMS

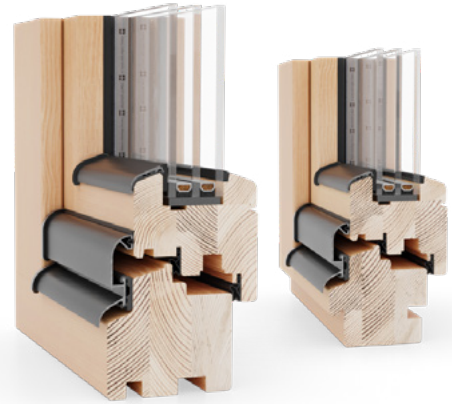

The following  $U_w$  value is given for a reference window with dimensions 4x6, with 4/16Ar/4one pane, wood type: pine

<b>3 1/8</b>	<b>1 3/8 - 1 3/4</b>	<b>3-4</b>	<b>4</b>	<b>2</b>	<b>0.14</b>
construction depth [in]	glazing units [in]	layers of glued wood	layers of varnish	gaskets	$U_w$ for $U_g = 0.18$ (the Ultimate frame)

Naturo 80 is a wooden system designed for use in energy-efficient construction. Warm frames, combined with glazing units up to 44 mm wide, allow for solutions with good thermal and acoustic performance.

Windows are available in standard, Belgian, Dutch, renovation, and monoblock versions. They also feature an outward-opening option.

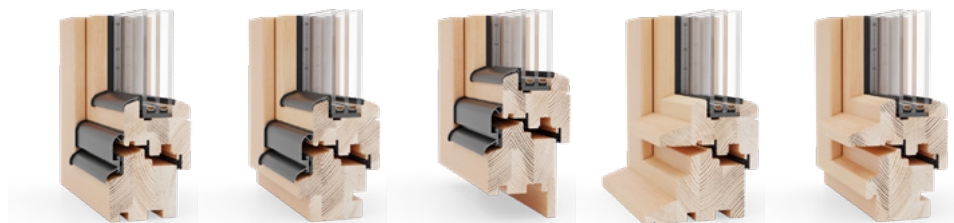

Standard profile  
(without an undercut)

Standard profile  
(with an undercut)

Renovation profile  
(without an undercut)

Belgian profile A  
(without an undercut)

Belgian profile A  
(with an undercut)

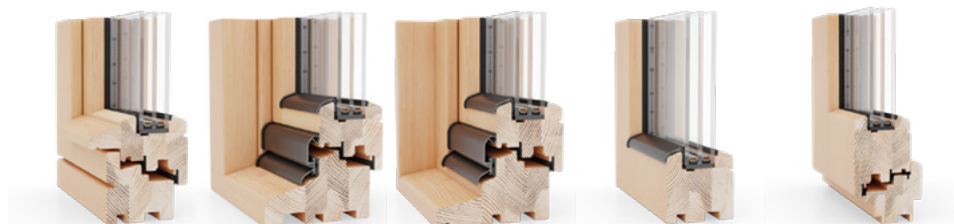

Belgian profile B  
(without an undercut)

Dutch profile  
(without an undercut)

Monoblock profile  
112/132/152/172

Fix profile  
(without an undercut)

Outward-opening  
profile  
(with an undercut)



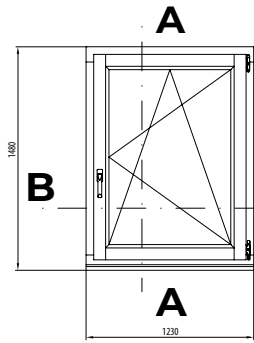

VERTICAL CROSS-SECTION A-A

# NATURO 80

## STANDARD

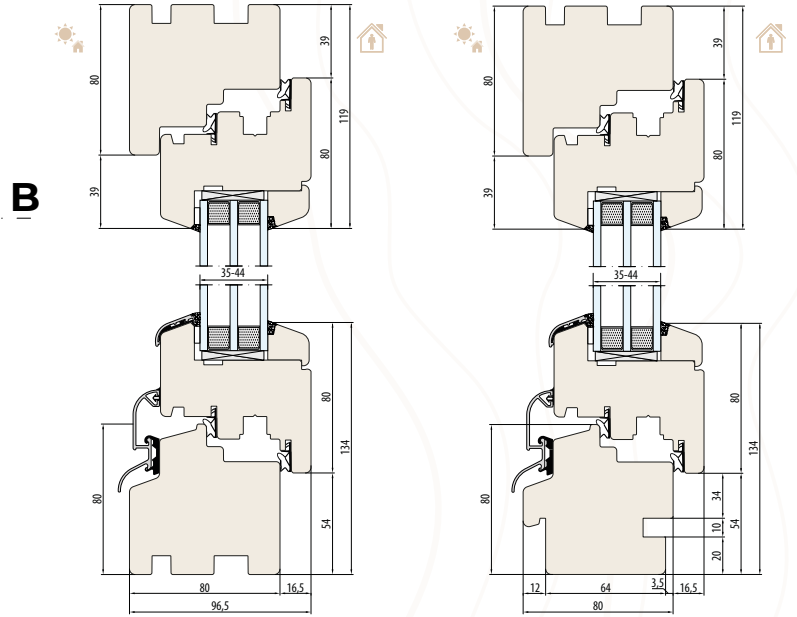

**NATURO 80 SYSTEM**  
Without undercut for the window sill

**NATURO 80 SYSTEM**  
The undercut for the interior and exterior window sill

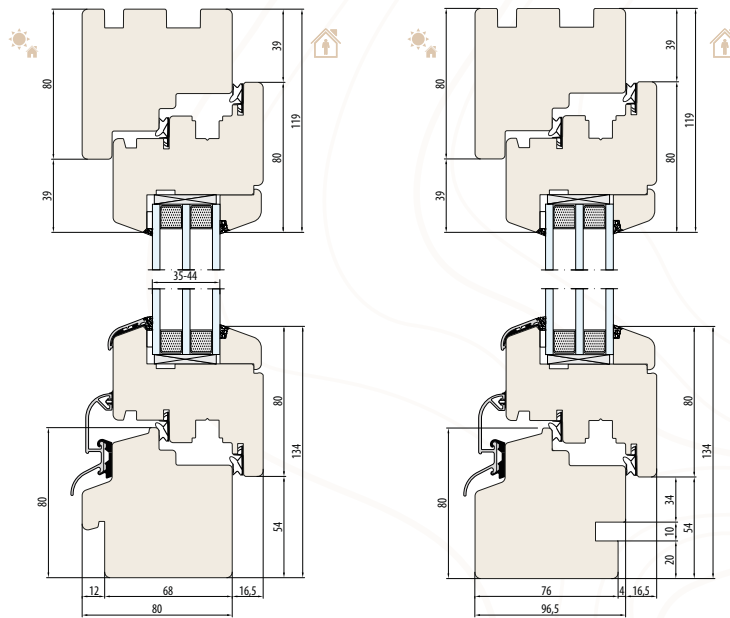

**NATURO 80 SYSTEM**  
The undercut for the exterior window sill

**NATURO 80 SYSTEM**  
The undercut for the interior window sill

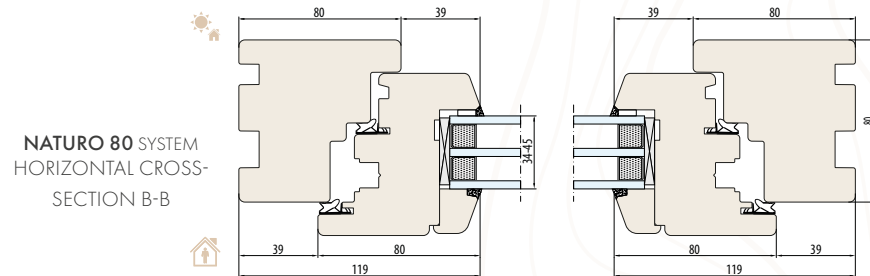

**NATURO 80 SYSTEM**  
HORIZONTAL CROSS-SECTION B-B

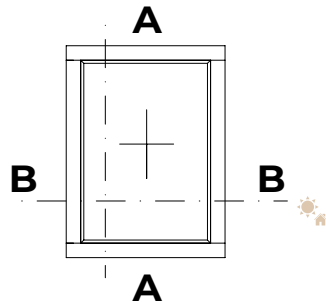

VERTICAL CROSS-SECTION A-A

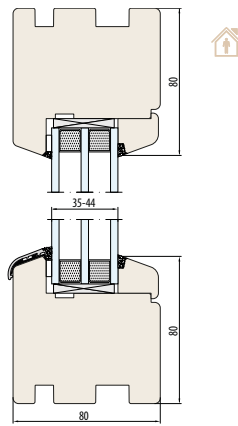

**NATURO 80 - FIX SYSTEM**  
Without undercut for the window sill

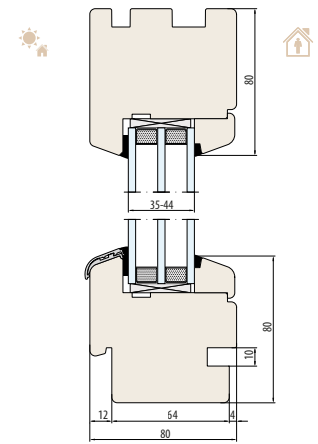

**NATURO 80 - FIX SYSTEM**  
The undercut for the interior and exterior window sill

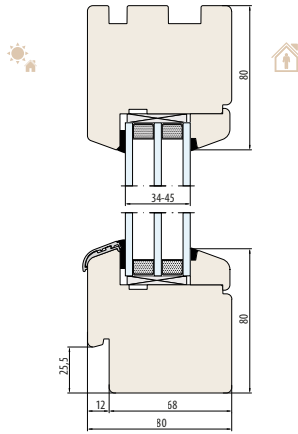

**NATURO 80 - FIX SYSTEM**  
The undercut for the exterior window sill

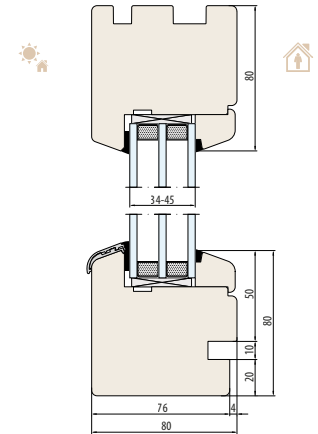

**NATURO 80 - FIX SYSTEM**  
The undercut for the interior window sill

# NATURO 80

FIX

**NATURO 80 - FIX SYSTEM**  
HORIZONTAL CROSS-SECTION B-B

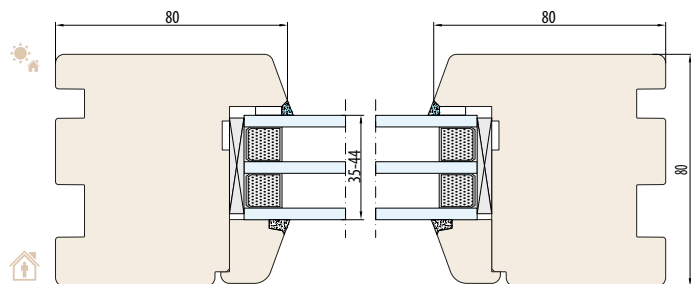

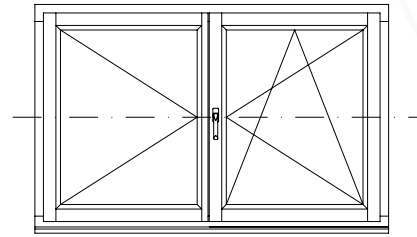

# NATURO 80

## MOVABLE POST

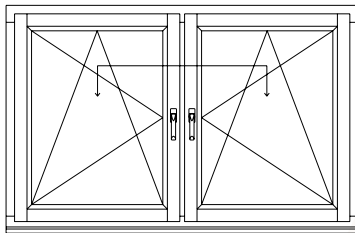
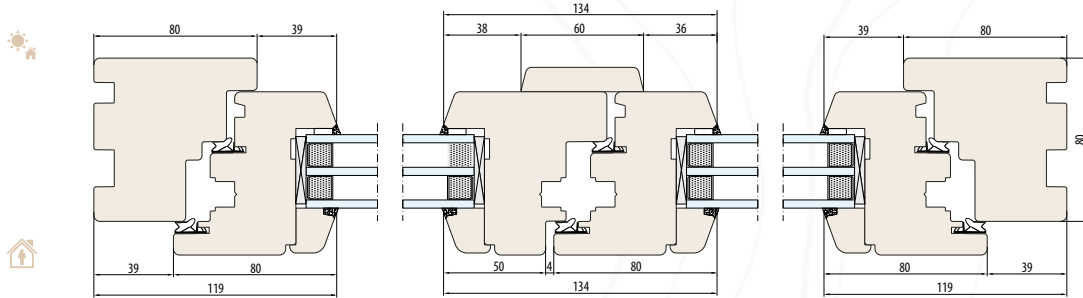

# NATURO 80

## FIXED POST

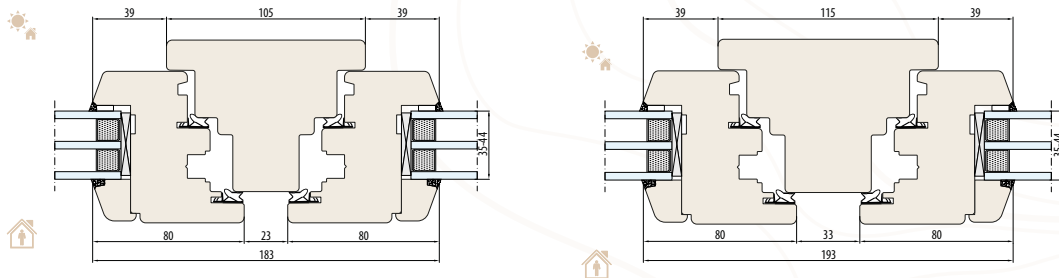

**NATURO 80 SYSTEM**  
fixed post 105 mm  
(Horizontal cross-section)

**NATURO 80 SYSTEM**  
fixed post 115 mm  
(Horizontal cross-section)

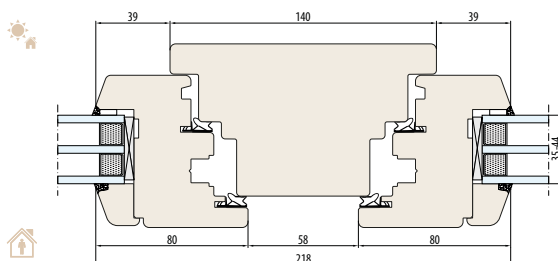

**NATURO 80 SYSTEM**  
fixed post 140 mm  
(Horizontal cross-section)



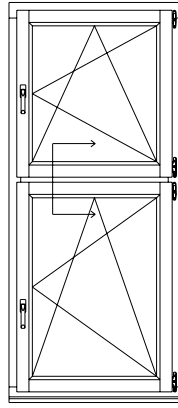

# NATURO 80

## TRANSOM BAR

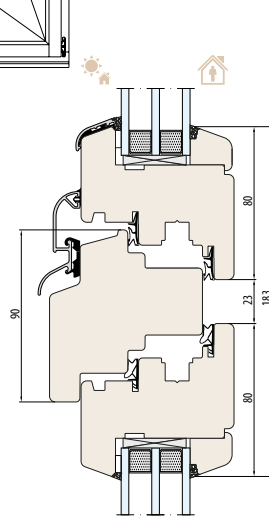

**NATURO 80 SYSTEM**  
transom bar 90 mm

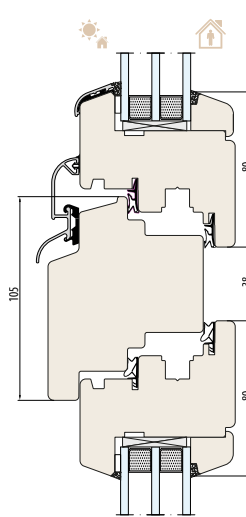

**NATURO 80 SYSTEM**  
transom bar 105 mm

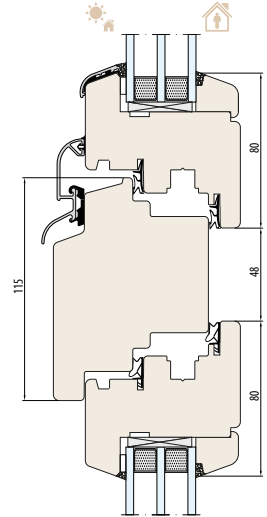

**NATURO 80 SYSTEM**  
transom bar 115 mm

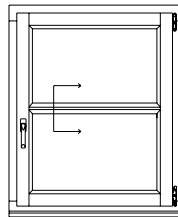

# NATURO 80

## MUNTIN BARS

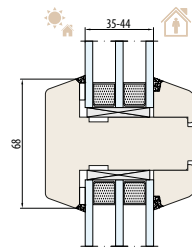

**NATURO 80 SYSTEM**  
Muntin bars 68 mm

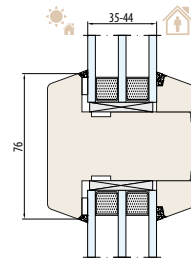

**NATURO 80 SYSTEM**  
Muntin bars 76 mm

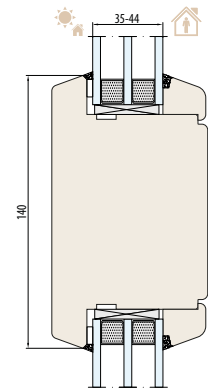

**NATURO 80 SYSTEM**  
Muntin bars 140 mm

# SPACER BARS

DEPENDENT ON THE THICKNESS OF THE GLAZING UNIT

## STANDARD GLAZING BEAD

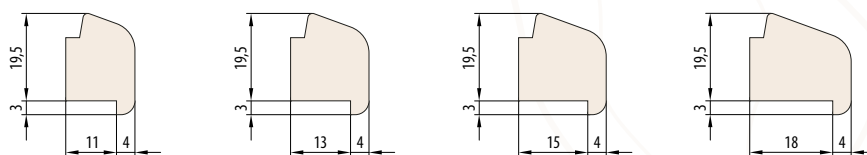

## RETRO GLAZING BEAD

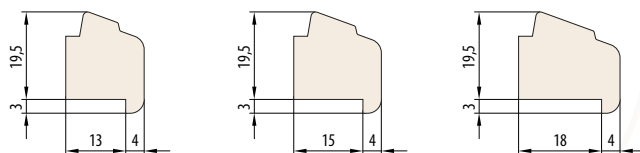

## OVERLAY GLAZING BEAD

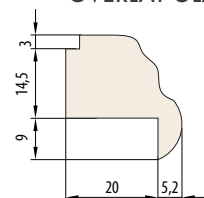

# NATURO 80 ALU

WINDOW SYSTEMS



The following  $U_w$  value is given for a reference window with dimensions 4x6, with 4/16Ar/4one pane, wood type: pine

<b>3 1/8</b>	<b>1 3/8 - 2</b>	<b>3-4</b>	<b>4</b>	<b>3</b>	<b>0.14</b>
construction depth [in]	glazing units [in]	layers of glued wood	layers of varnish	gaskets	$U_w$ for $U_g = 0.18$ (the Ultimate frame)

Naturo 80 ALU is a system with excellent thermal and acoustic performance, combined with the aesthetics of aluminium shells.

It represents the perfect balance between ecology, functional parameters, and cost for windows that are expected to be durable and make an impressive contribution to a modern facade. This system features the simple and completely invisible G-FIX solution, which presses the glass against the gasket, as well as dry glazing that facilitates the replacement of the insulated glazing unit.

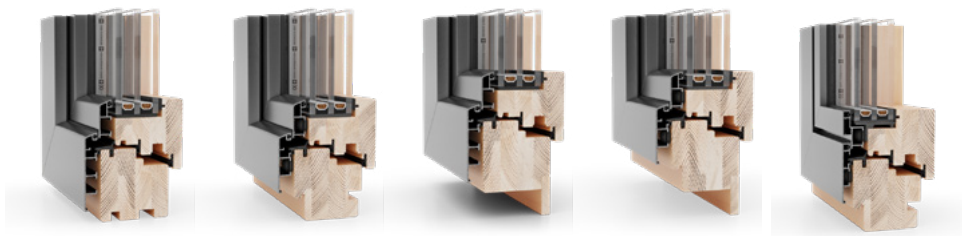

Gemini Classic  
Standard profile  
(without an undercut)

Gemini Classic  
Standard profile  
(with an undercut)

Gemini Classic  
Renovation profile  
(without an undercut)

Gemini Classic  
Renovation profile  
(with an undercut)

Gemini Quadrat FB  
Standard profile  
(with an undercut)



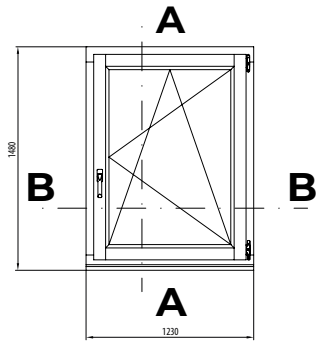

VERTICAL CROSS-SECTION A-A

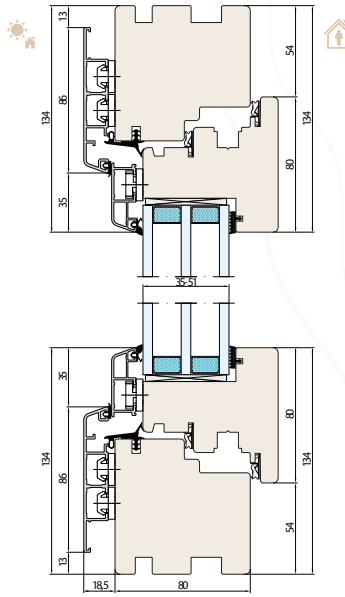

**NATURO 80 ALU SYSTEM**  
*GEMINI CLASSIC*  
Without undercut for the window sill

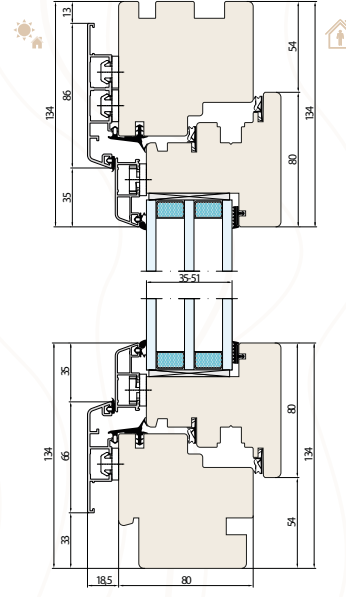

**NATURO 80 ALU SYSTEM**  
*GEMINI CLASSIC*  
The undercut for the interior and exterior window sill

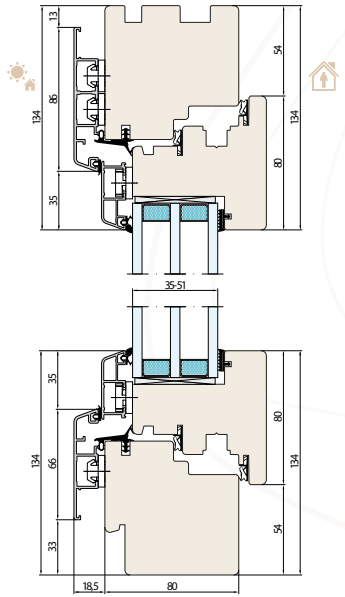

**NATURO 80 ALU SYSTEM**  
*GEMINI CLASSIC*  
The undercut for the exterior window sill

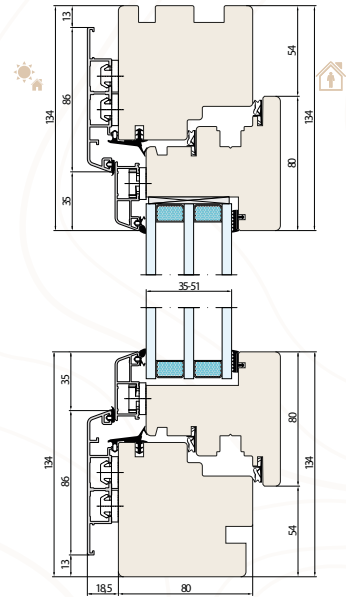

**NATURO 80 ALU SYSTEM**  
*GEMINI CLASSIC*  
The undercut for the interior window sill

# NATURO 80 ALU

STANDARD

**NATURO 80 ALU SYSTEM**  
*GEMINI CLASSIC*  
HORIZONTAL  
CROSS-SECTION B-B

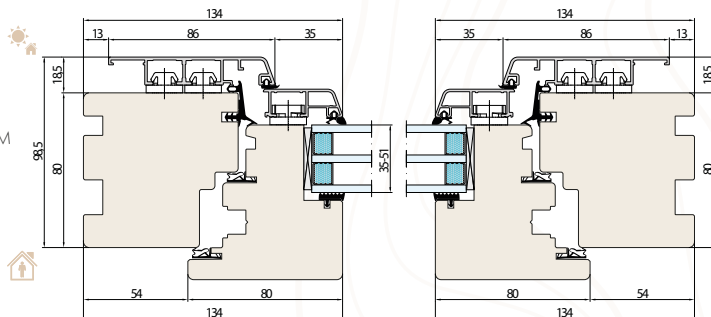

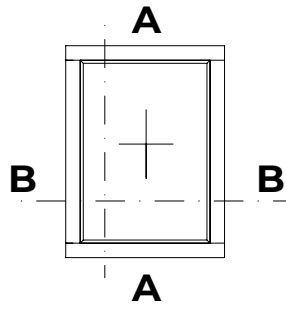

VERTICAL CROSS-SECTION A-A

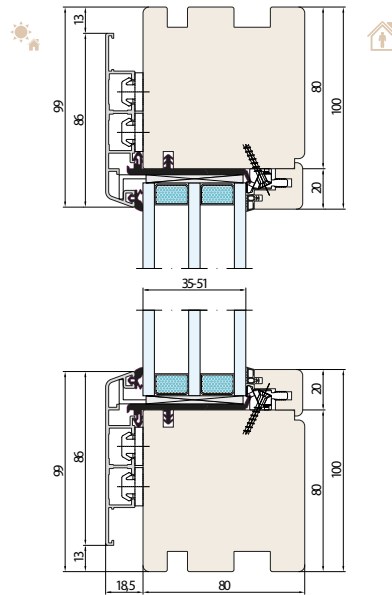

NATURO 80 ALU-FIX SYSTEM  
GEMINI CLASSIC  
Without undercut for the window sill

# NATURO 80 ALU

FIX

NATURO 80ALU-FIX SYSTEM  
GEMINI CLASSIC

HORIZONTAL CROSS-SECTION B-B

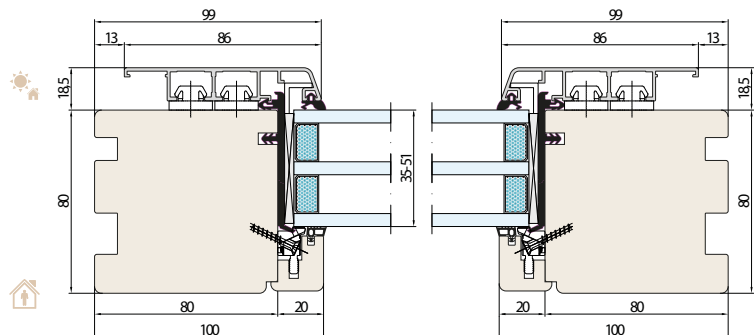

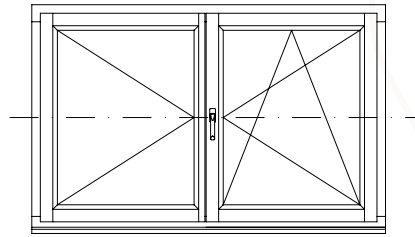

# NATURO 80 ALU

## MOVABLE POST

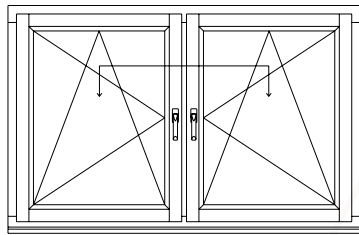
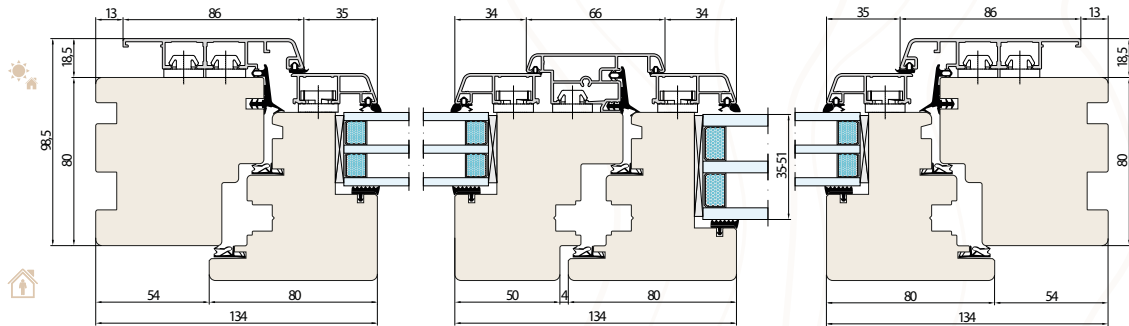

# NATURO 80 ALU

## FIXED POST

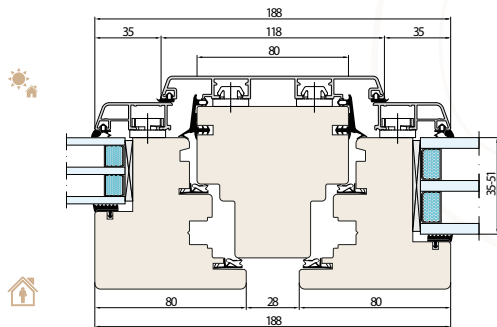

**NATURO 80 ALU SYSTEM**  
*GEMINI CLASSIC*  
 fixed post 80 mm  
 (Horizontal cross-section)

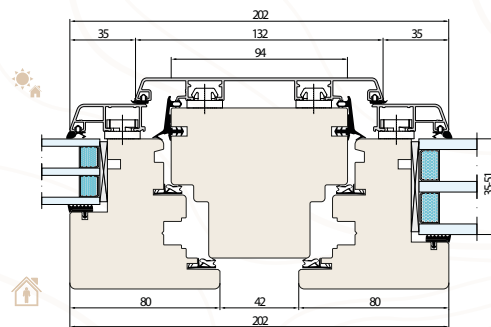

**NATURO 80 ALU SYSTEM**  
*GEMINI CLASSIC*  
 fixed post 94 mm  
 (Horizontal cross-section)

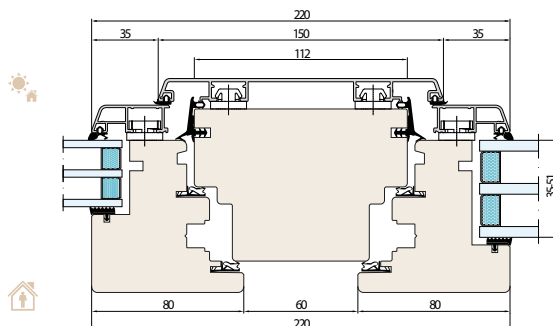

**NATURO 80 ALU SYSTEM**  
*GEMINI CLASSIC*  
 fixed post 112 mm  
 (Horizontal cross-section)

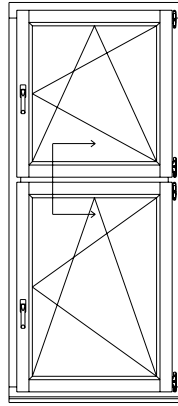

# NATURO 80 ALU

## TRANSOM BAR

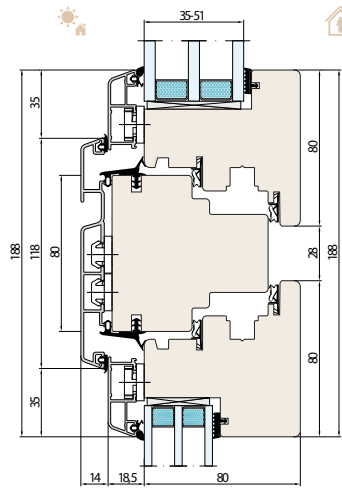

NATURO 80 ALU SYSTEM  
GEMINI CLASSIC  
transom bar 80 mm

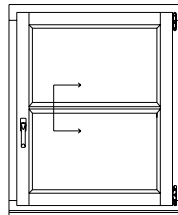

# NATURO 80 ALU

## MUNTIN BAR

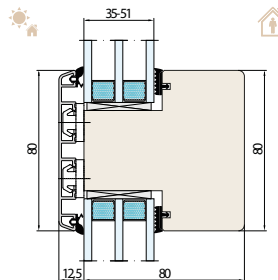

NATURO 80 ALU SYSTEM  
GEMINI CLASSIC  
Muntin bar 80 mm



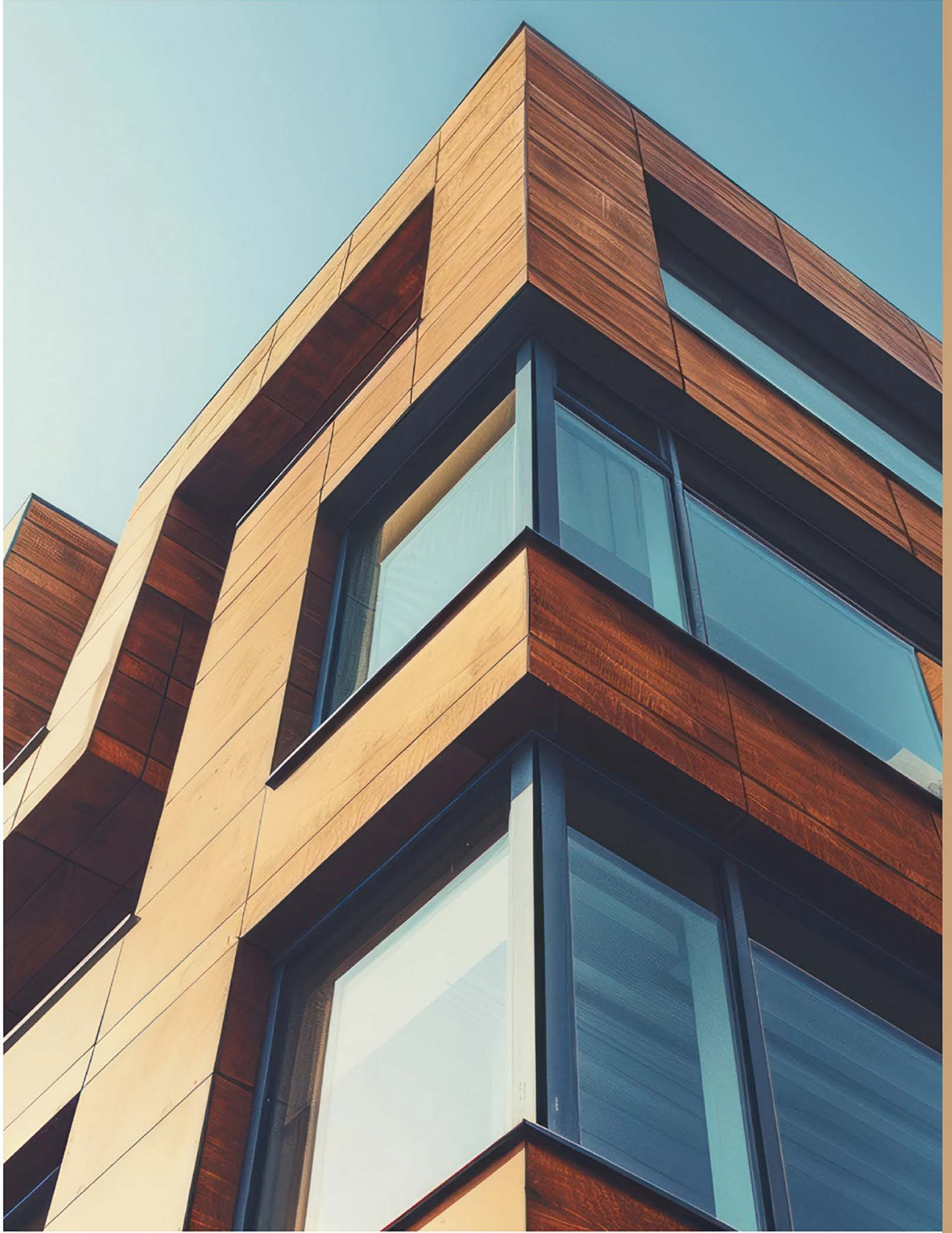



# NATURO 92

## WINDOW SYSTEMS



The following  $U_w$  value is given for a reference window with dimensions 4x6, with 4/16Ar/4one pane, wood type: pine

<b>3 5/8</b>	<b>1 13/16- 2 3/16</b>	<b>4</b>	<b>4</b>	<b>2</b>	<b>0.14</b>
construction depth [in]	glazing units [in]	layers of glued wood	layers of varnish	gaskets	$U_w$ for $U_g = 0.18$ (the Ultimate frame)

This is a wooden system with the best thermal and acoustic performance, allowing for the use of the most efficient glazing units. Choosing Naturo 92, like other wooden systems, is an investment for years, especially in passive building.

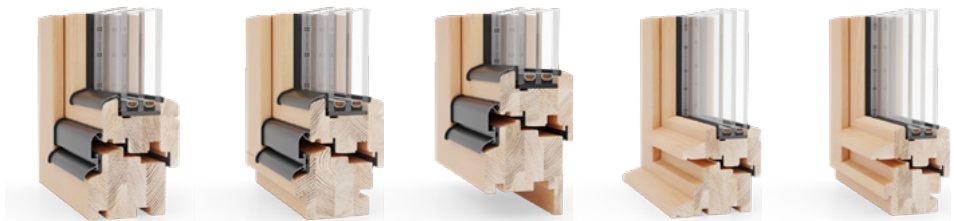

Standard profile  
(without an undercut)

Standard profile  
(with an undercut)

Renovation profile  
(without an undercut)

Belgian profile A  
(without an undercut)

Belgian profile A  
(with an undercut)



Belgian profile B  
(without an undercut)

Dutch profile  
(without an undercut)

Monoblock profile  
124/144/164/184

Fix profile  
(without an undercut)

Fix profile  
(with an undercut)

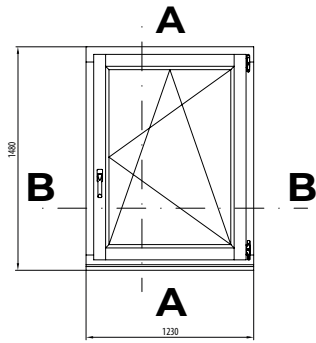

VERTICAL CROSS-SECTION A-A

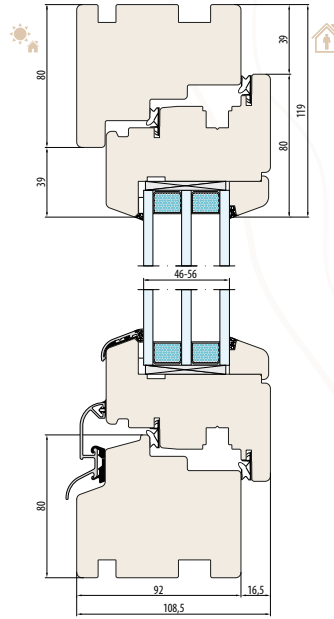

**NATURO 92 SYSTEM**  
Without undercut for the window sill

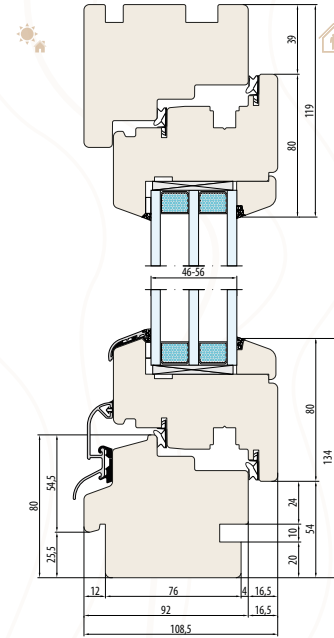

**NATURO 92 SYSTEM**  
The undercut for the interior and exterior window sill

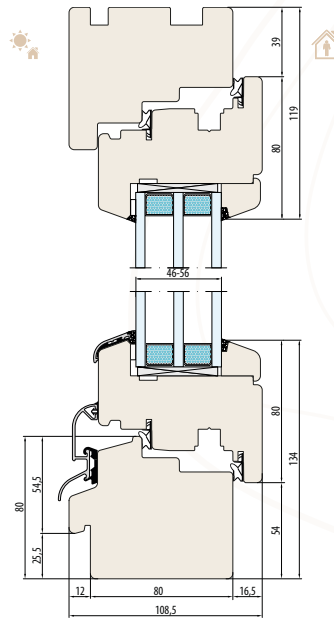

**NATURO 92 SYSTEM**  
The undercut for the exterior window sill

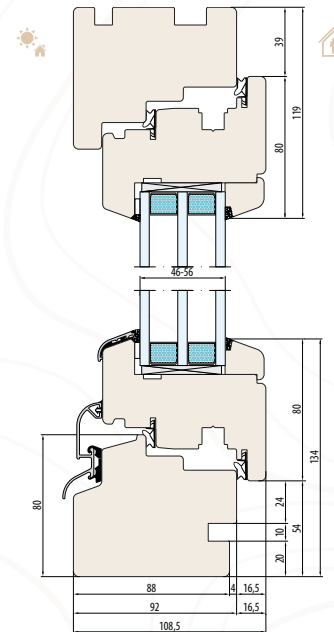

**NATURO 92 SYSTEM**  
The undercut for the interior window sill

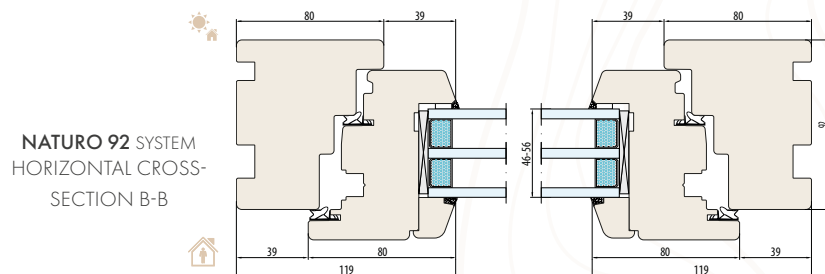

**NATURO 92 SYSTEM**  
HORIZONTAL CROSS-SECTION B-B

# NATURO 92

## STANDARD



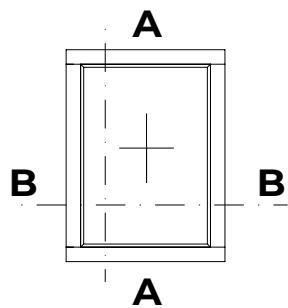

PRZEKRÓJ PIONOWY A-A

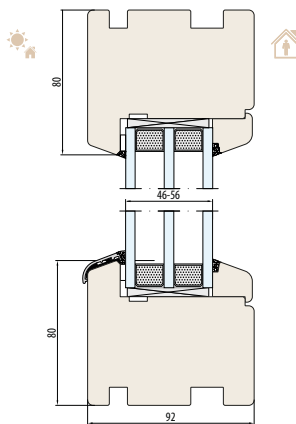

NATURO 92-FIX SYSTEM  
Without undercut for the window sill

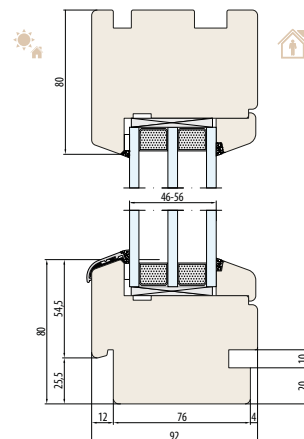

NATURO 92-FIX SYSTEM  
The undercut for the interior and exterior window sill

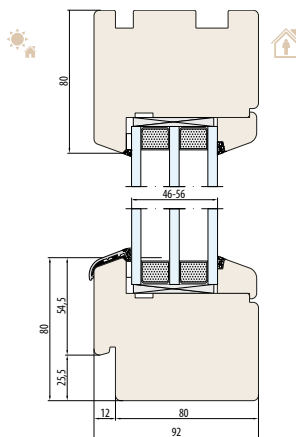

NATURO 92-FIX SYSTEM  
The undercut for the exterior window sill

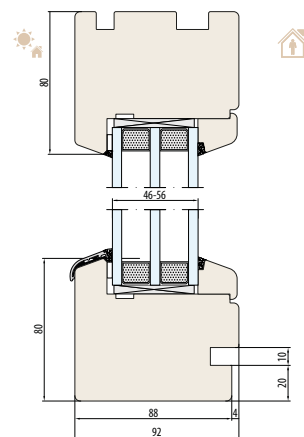

NATURO 92-FIX SYSTEM  
The undercut for the interior window sill

# NATURO 92

FIX

NATURO 92-FIX SYSTEM  
HORIZONTAL CROSS-SECTION B-B

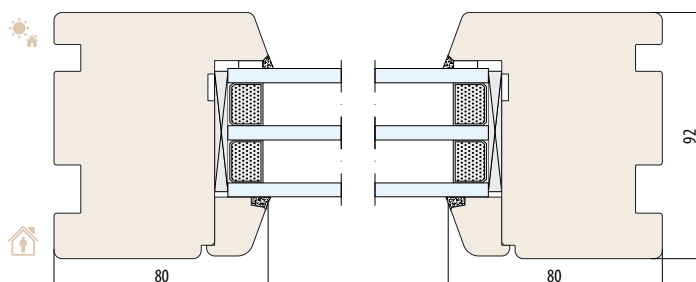



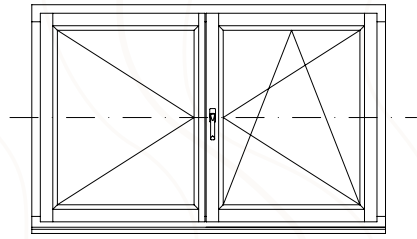

# NATURO 92

## MOVABLE POST

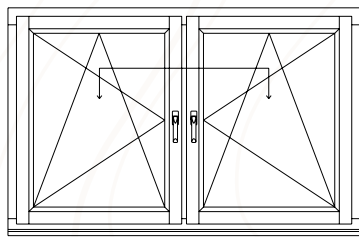
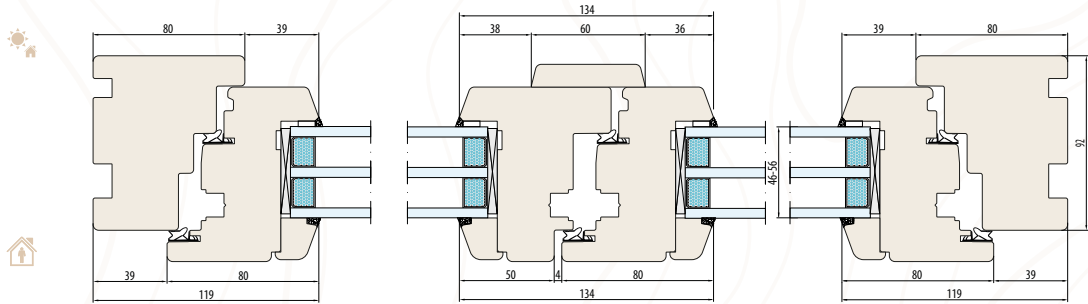

# NATURO 92

## FIXED POST

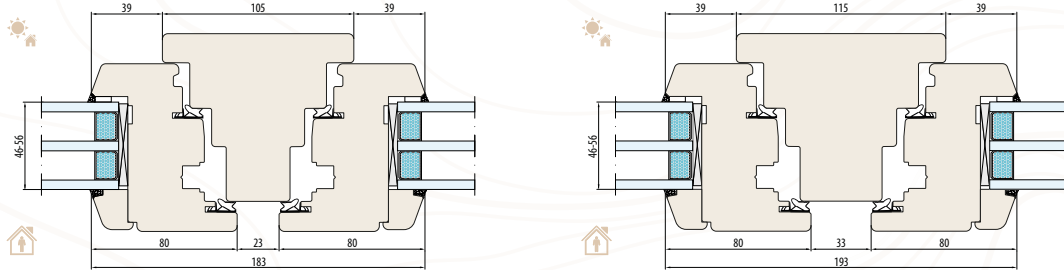

**NATURO 92 SYSTEM**  
fixed post 105 mm  
(Horizontal cross-section)

**NATURO 92 SYSTEM**  
fixed post 115 mm  
(Horizontal cross-section)

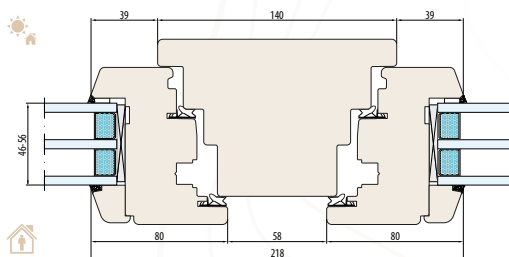

**NATURO 92 SYSTEM**  
fixed post 140 mm  
(Horizontal cross-section)

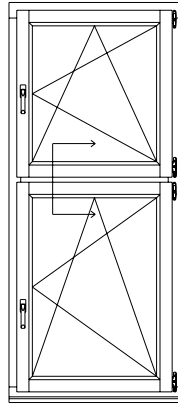

## NATURO 92

### TRANSOM BAR

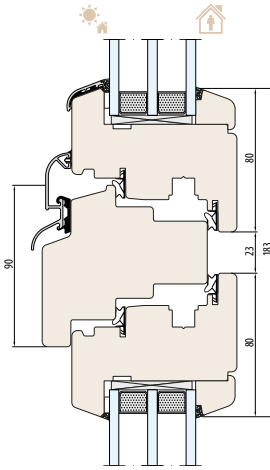

NATURO 92 SYSTEM  
transom bar 90 mm

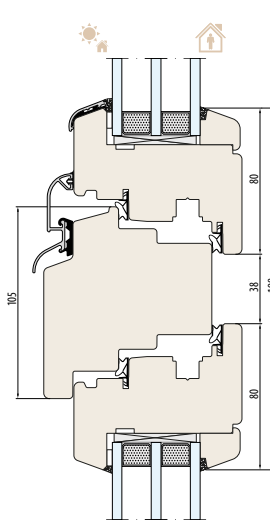

NATURO 92 SYSTEM  
transom bar 105 mm

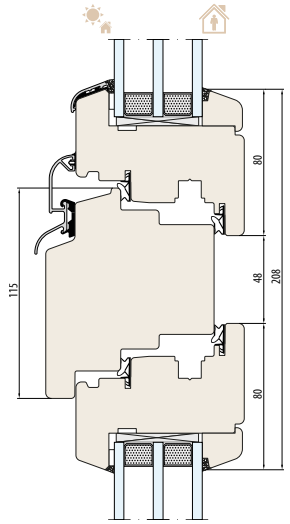

NATURO 92 SYSTEM  
transom bar 115 mm

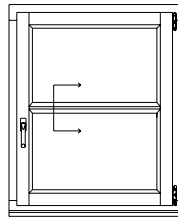

## NATURO 92

### MUNTIN BARS

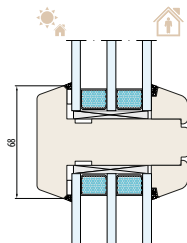

NATURO 92 SYSTEM  
Muntin bar 68 mm

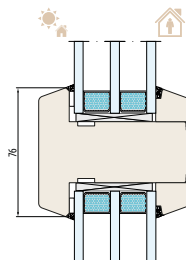

NATURO 92 SYSTEM  
Muntin bar 76 mm

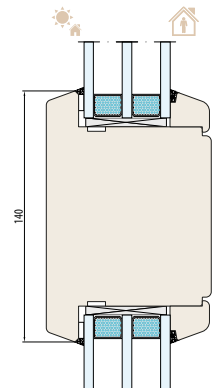

NATURO 92 SYSTEM  
Muntin bar 140 mm

# SPACER BARS

DEPENDENT ON THE THICKNESS OF THE GLAZING UNIT

## STANDARD GLAZING BEAD

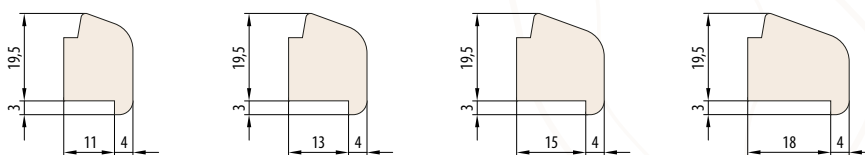

## RETRO GLAZING BEAD

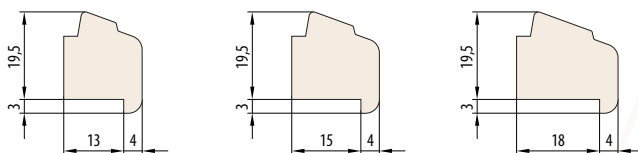

## OVERLAY GLAZING BEAD

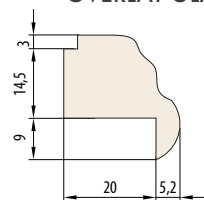





# ESPERIA LIFE 74 ALU

WINDOW SYSTEMS



The following  $U_w$  value is given for a reference window with dimensions 4x6, with 4/16Ar/4one pane, wood type: pine

<b>2 15/16</b>	<b>15/16 - 1 7/8</b>	<b>4</b>	<b>4</b>	<b>3</b>	<b>0.14</b>
construction depth [in]	glazing units [in]	layers of glued wood	layers of varnish	gaskets	$U_w$ for $U_g = 0.18$ (the Ultimate frame)

Esperia 74 ALU is a slim wooden window enhanced with the features of an aluminium window. The system can accommodate glazing units up to 48 mm thick, which results in higher acoustic insulation. The presence of aluminium shells on the outside eliminates the susceptibility of wood to mechanical damage and increases the durability of the entire structure. Its use is an investment in effective energy efficiency.



Standard profile  
(with an undercut)

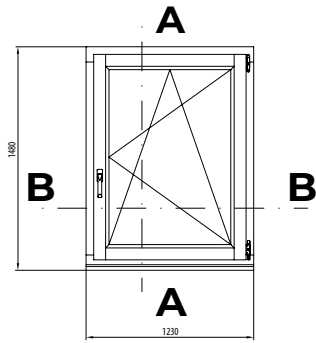

VERTICAL CROSS-SECTION A-A

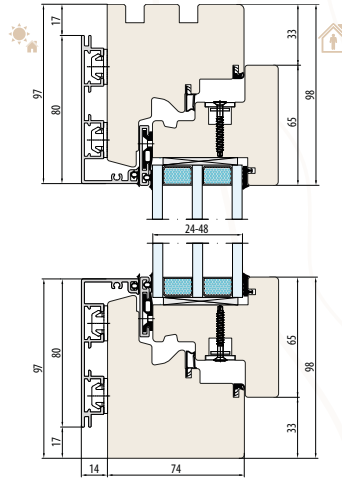

ESPERIA LIFE 74 ALU SYSTEM  
Without undercut for the window sill

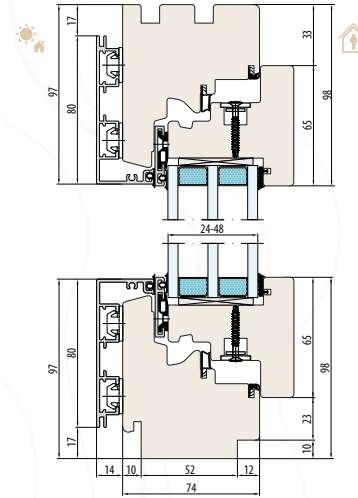

ESPERIA LIFE 74 ALU SYSTEM  
The undercut for the interior and exterior window sill

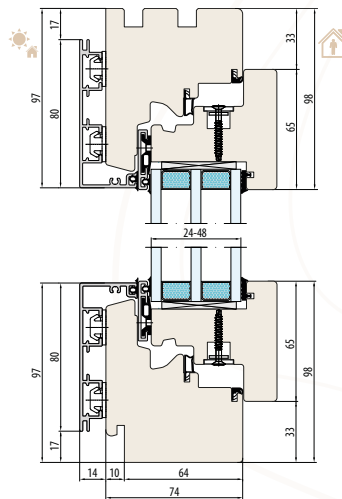

ESPERIA LIFE 74 ALU SYSTEM  
The undercut for the exterior window sill

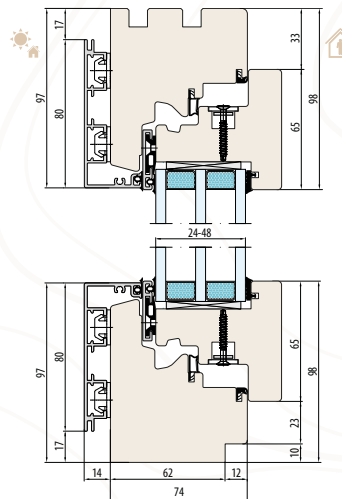

ESPERIA LIFE 74 ALU SYSTEM  
The undercut for the interior window sill

ESPERIA LIFE 74 ALU SYSTEM  
HORIZONTAL CROSS-SECTION B-B

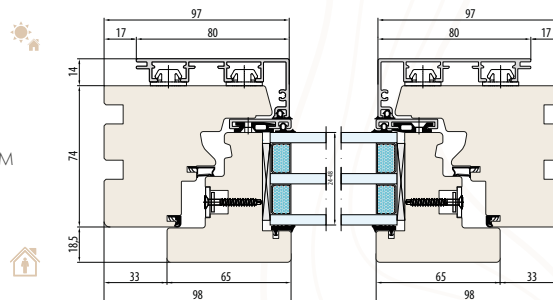

# ESPERIA LIFE 74 ALU STANDARD



# ESPERIA LIFE 74 ALU

**FIX**

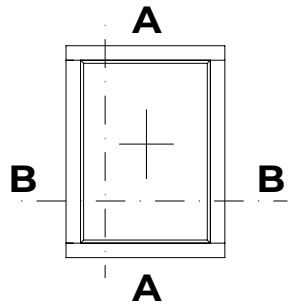

VERTICAL CROSS-SECTION A-A

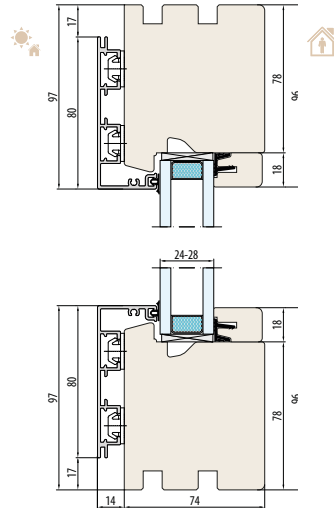

ESPERIA LIFE 74 ALU-FIX SYSTEM  
Without undercut for the window sill

ESPERIA LIFE 74 ALU-FIX SYSTEM  
HORIZONTAL CROSS-SECTION B-B

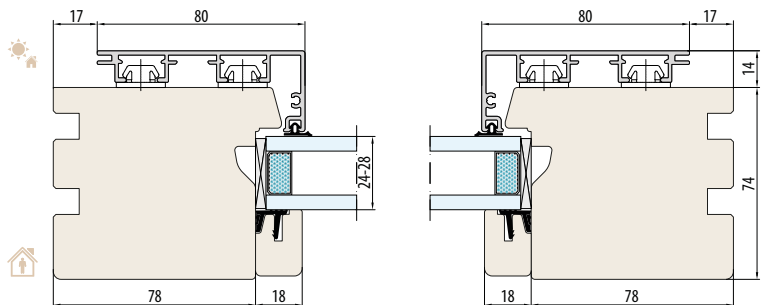



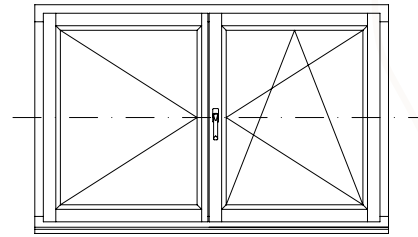

# ESPERIA LIFE 74 ALU

## MOVABLE POST

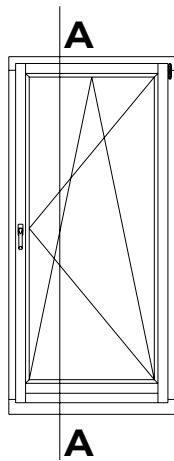
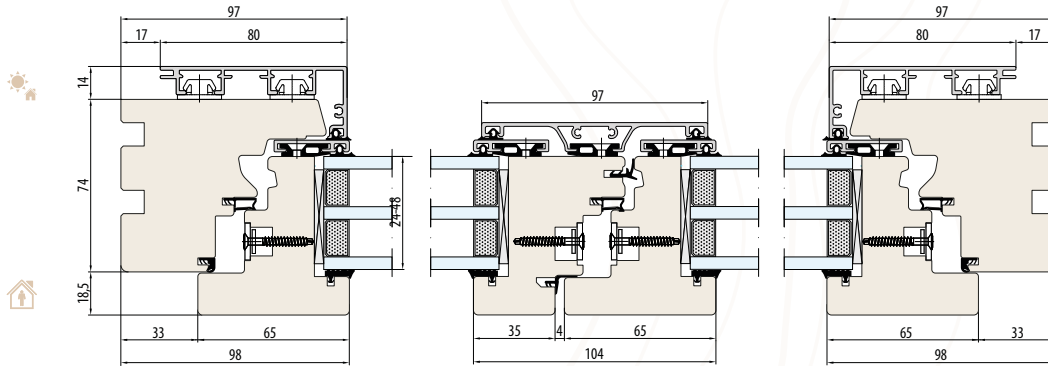

# ESPERIA LIFE 74 ALU

## BALCONY DOORS

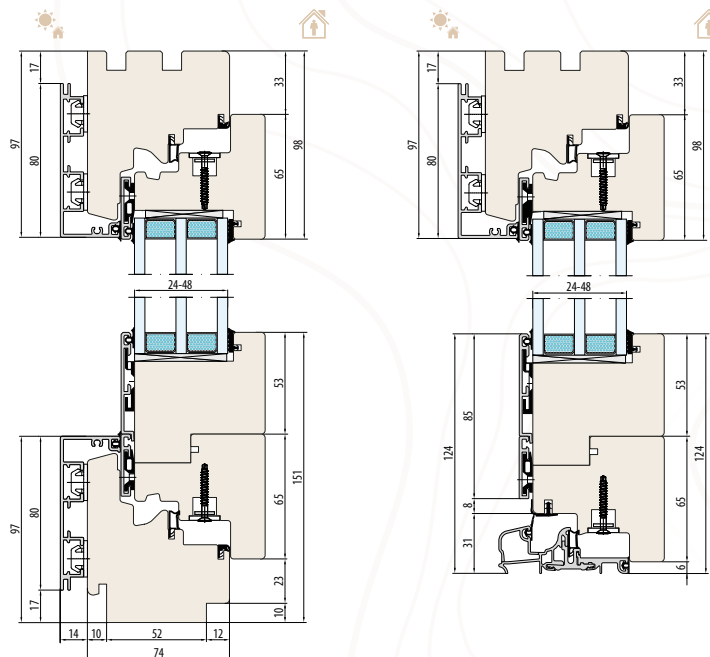

ESPERIA LIFE 74 ALU SYSTEM  
one-sash balcony doors on high threshold

ESPERIA LIFE 74 ALU SYSTEM  
one-sash balcony doors on low threshold



# ESPERIA LIFE 80

## WINDOW SYSTEMS



The following  $U_w$  value is given for a reference window with dimensions 4x6, with 4/16Ar/4one pane, wood type: pine

<b>3 1/8</b>	<b>15/16 - 1 7/8</b>	<b>4</b>	<b>4</b>	<b>3</b>	<b>015</b>
construction depth [in]	glazing units [mm]	layers of glued wood	layers of varnish	gaskets	$U_w$ for $U_g = 0.18$ (the Ultimate frame)

Esperia Life 80 windows are a premium offering that allows for the use of 48 mm glazing units. This means very high thermal insulation and acoustic insulation parameters. Combined with warm spacers and three EPDM seals, the system becomes a fitting solution for any investment.



Standard profile  
(with an undercu)

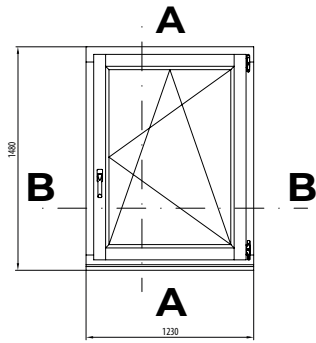

VERTICAL CROSS-SECTION A-A

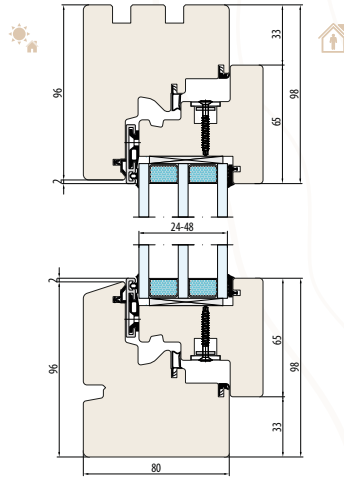

**ESPERIA LIFE 80 SYSTEM**  
Without undercut for the window sill

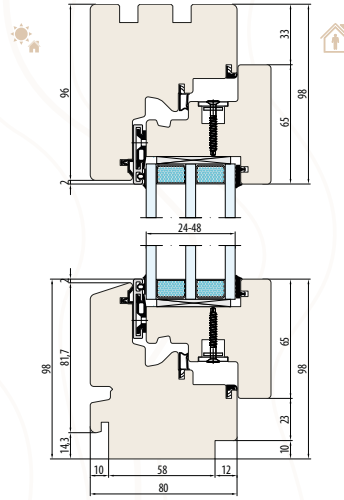

**ESPERIA LIFE 80 SYSTEM**  
The undercut for the interior and exterior window sill

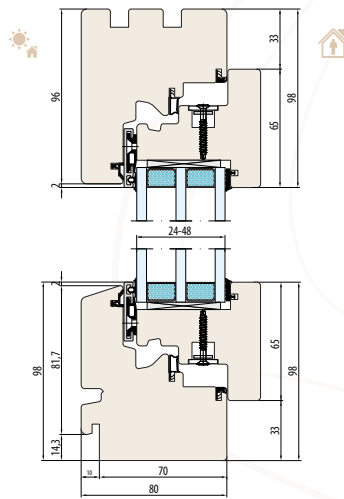

**ESPERIA LIFE 80 SYSTEM**  
The undercut for the exterior window sill

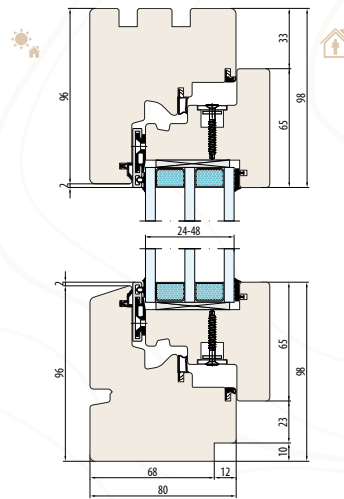

**ESPERIA LIFE 80 SYSTEM**  
The undercut for the interior window sill

**ESPERIA LIFE 80 SYSTEM**  
HORIZONTAL CROSS-SECTION B-B

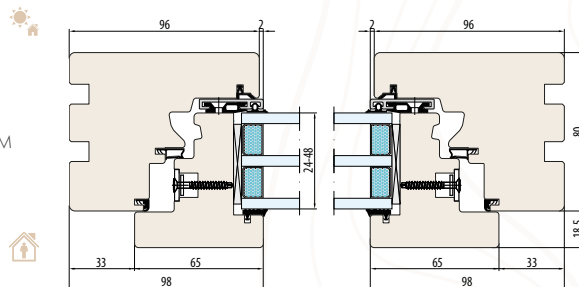

# ESPERIA LIFE 80

## STANDARD





# ESPERIA LIFE 80

**FIX**

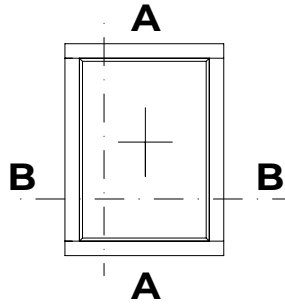

VERTICAL CROSS-SECTION A-A

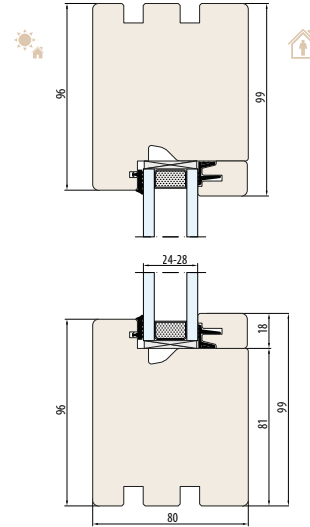

**ESPERIA LIFE 80-FIX SYSTEM**  
Without undercut for the window sill

**ESPERIA LIFE 80-FIX SYSTEM**  
HORIZONTAL CROSS-SECTION B-B

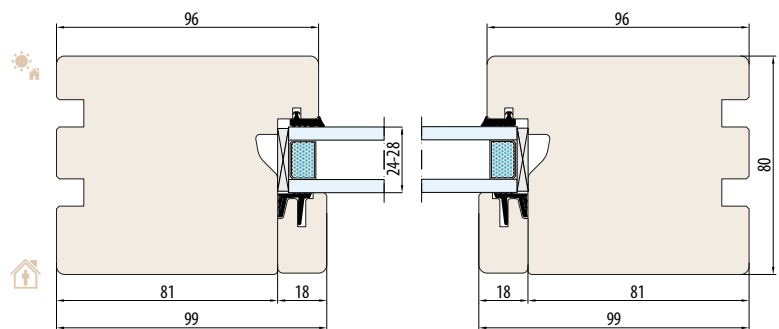

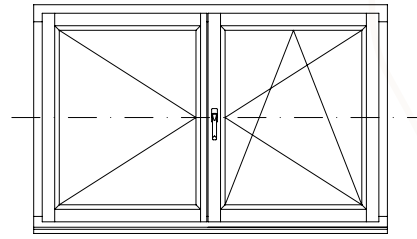

# ESPERIA LIFE 80

## MOVABLE POST

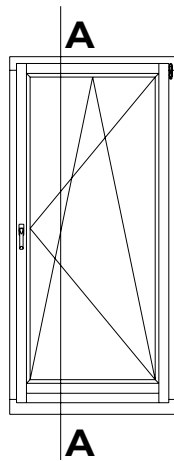
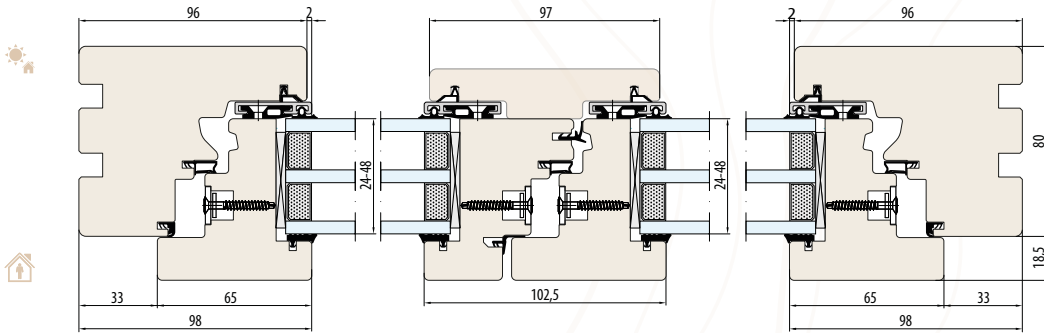

# ESPERIA LIFE 80

## BALCONY DOORS

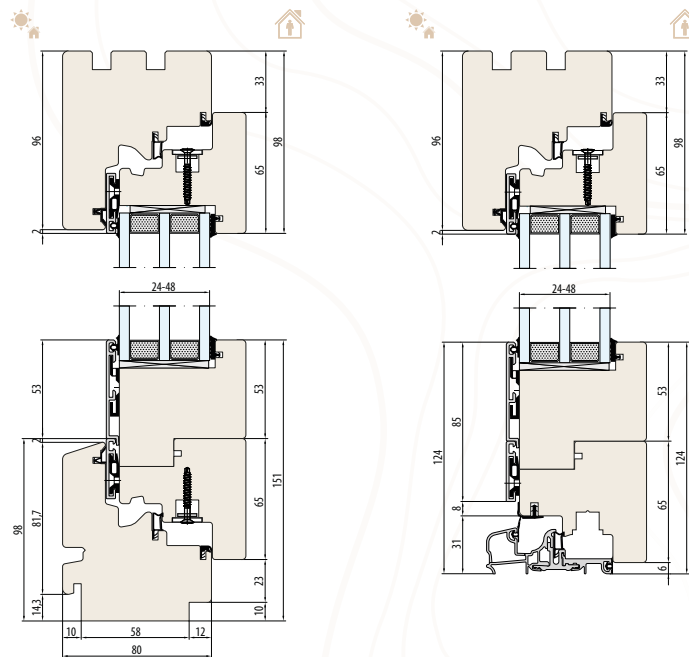

ESPERIA LIFE 80 SYSTEM  
one-sash balcony doors on high  
threshold

ESPERIA LIFE 80 SYSTEM  
one-sash balcony doors on low  
threshold



# NATURO 68 HST

LIFT-AND-SLIDE SYSTEM

9

construction  
height [ft]

1-2

guiding rails

6 7/16

construction  
depth [in]

Naturo 68 HST is a relatively lightweight lift-and-slide wooden system characterized by its shallow installation depth for a product in its class. It allows for easy operation of even large-scale constructions. It allows for easy operation of even large-scale constructions. This system enables the creation of large glazings, perfectly fitting to current architectural trends, and the low-threshold design significantly facilitates movement between the interior of the house and the terrace or garden.

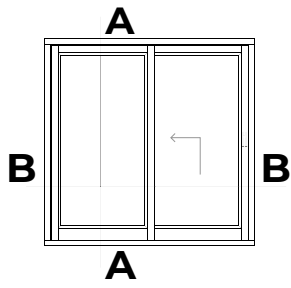

**NATURO 68 HST SYSTEM**  
(general dimensions) - threshold 22 mm - scheme 'A'

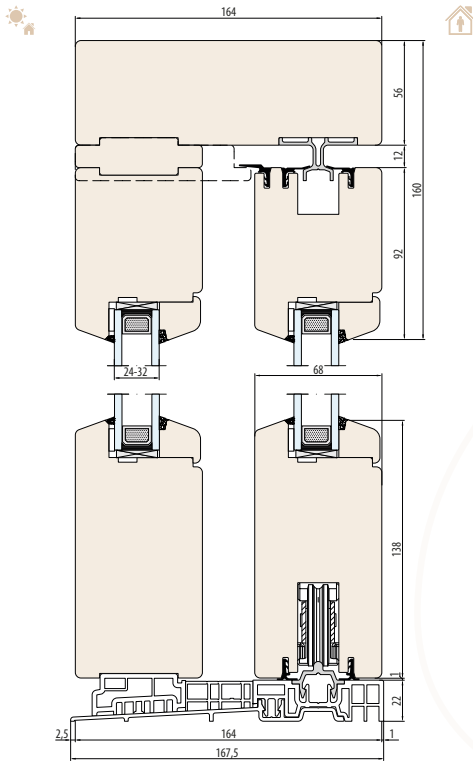

**NATURO 68 HST SYSTEM**  
(general dimensions) - threshold 50 mm - scheme 'A'

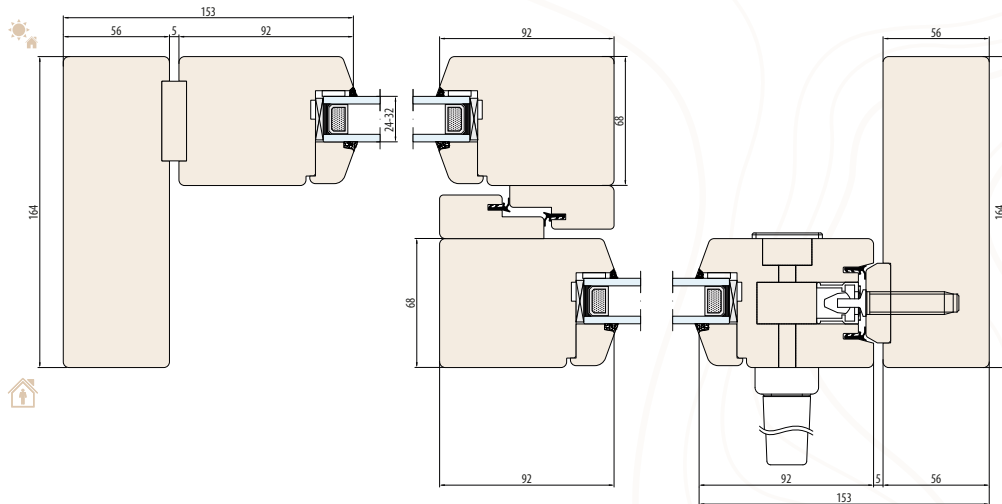
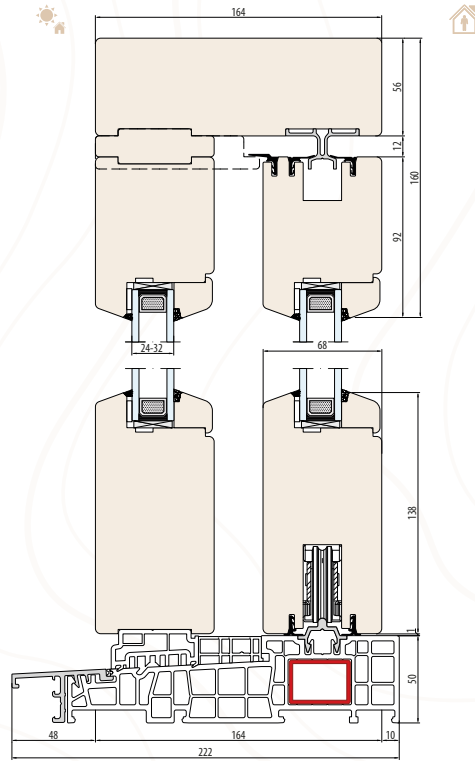



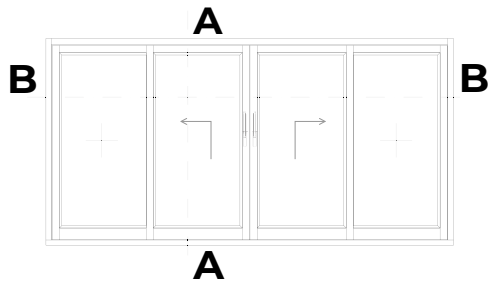

**NATURO 68 HST SYSTEM**  
(general dimensions) - threshold 22 mm - scheme 'C'

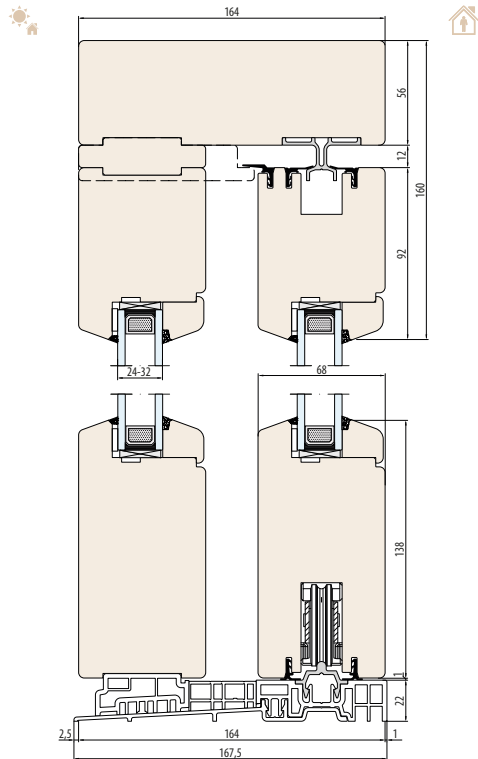

**NATURO 68 HST SYSTEM**  
(general dimensions) - threshold 50 mm - scheme 'C'

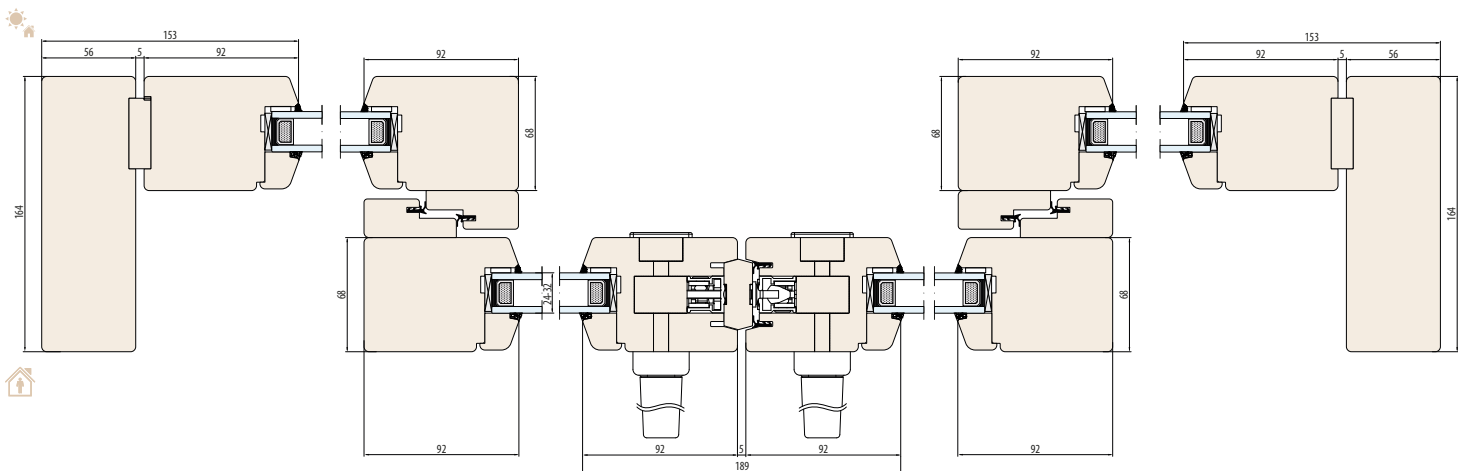
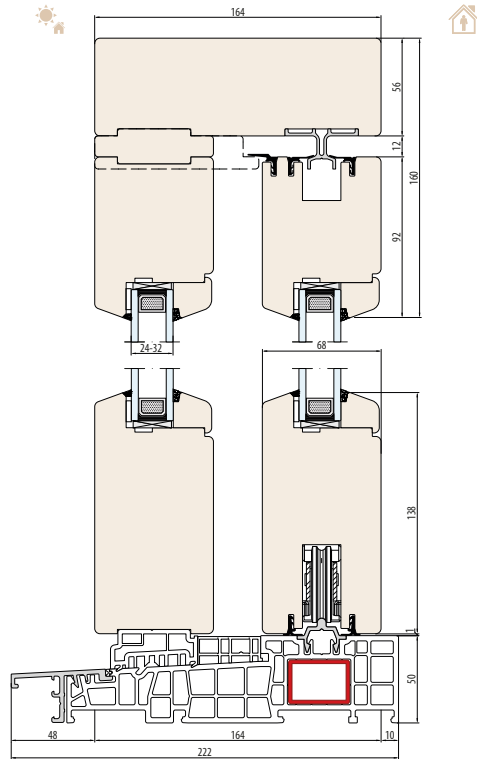

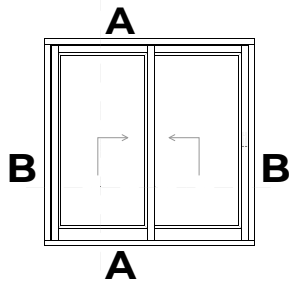

**NATURO 68 HST SYSTEM**  
(general dimensions) - threshold 22 mm - scheme 'D'

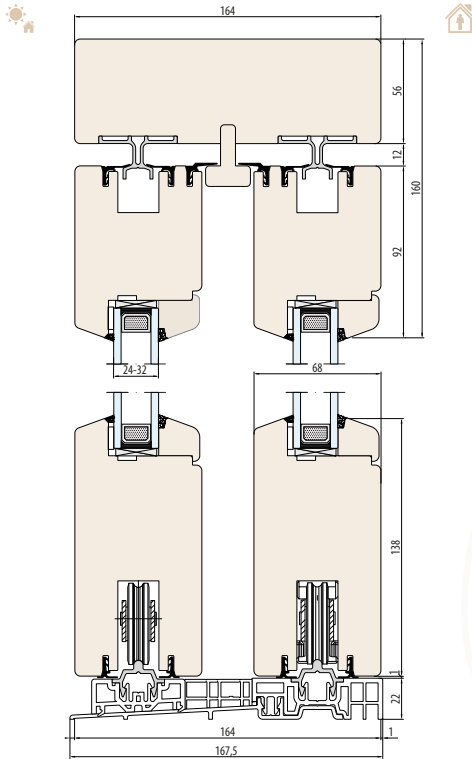

**NATURO 68 HST SYSTEM**  
(general dimensions) - threshold 50 mm - scheme 'D'

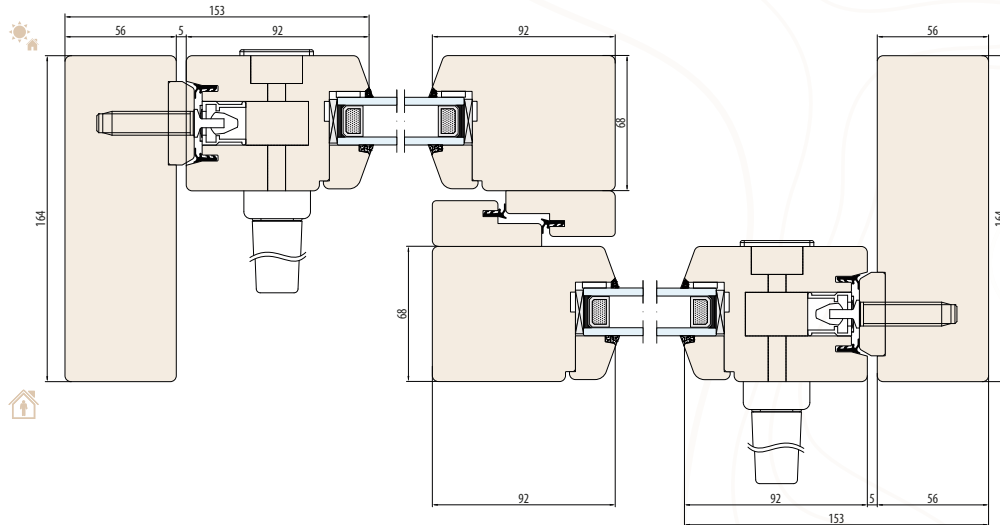
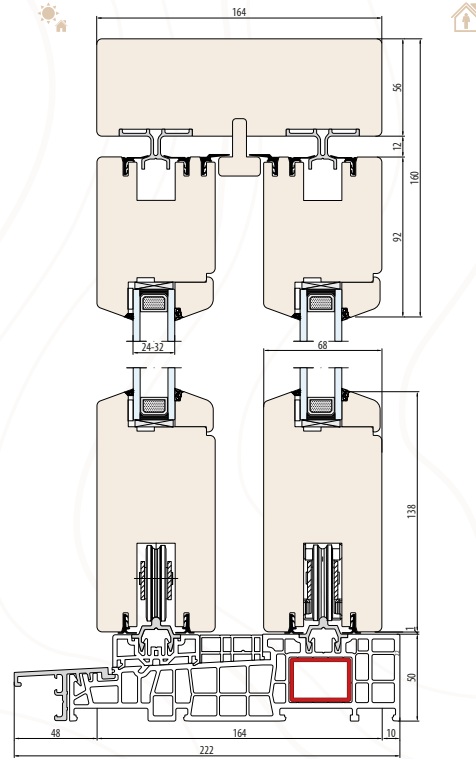



## NATURO 80 HST

LIFT-AND-SLIDE SYSTEM

9

construction  
height [ft]

1-2

guiding rails

7 3/8

construction  
depth [in]

Naturo 80 HST is an elegant wooden lift-and-slide system with powerful and durable sashes that, despite their large size, look sleek and dynamic. The high weight of the sashes increases the tightness in the closed position. Its versatile design allows it to adapt to any architectural style, highlighting the natural beauty of wood or giving it a uniform color

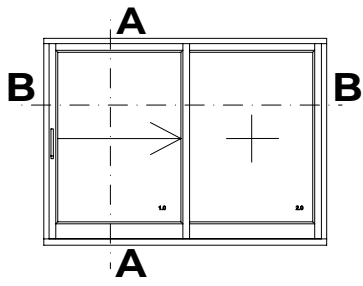

**NATURO 80 HST SYSTEM**  
 (general dimensions) - threshold 24 mm - scheme 'A'

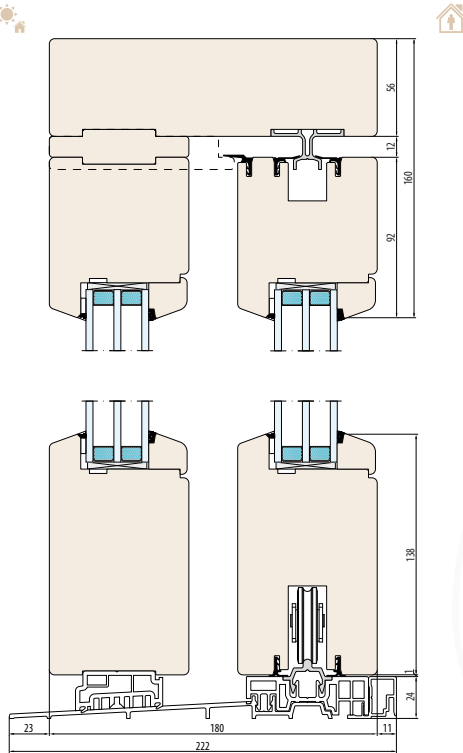

**NATURO 80 HST SYSTEM**  
 (general dimensions) - threshold 50 mm - scheme 'A'

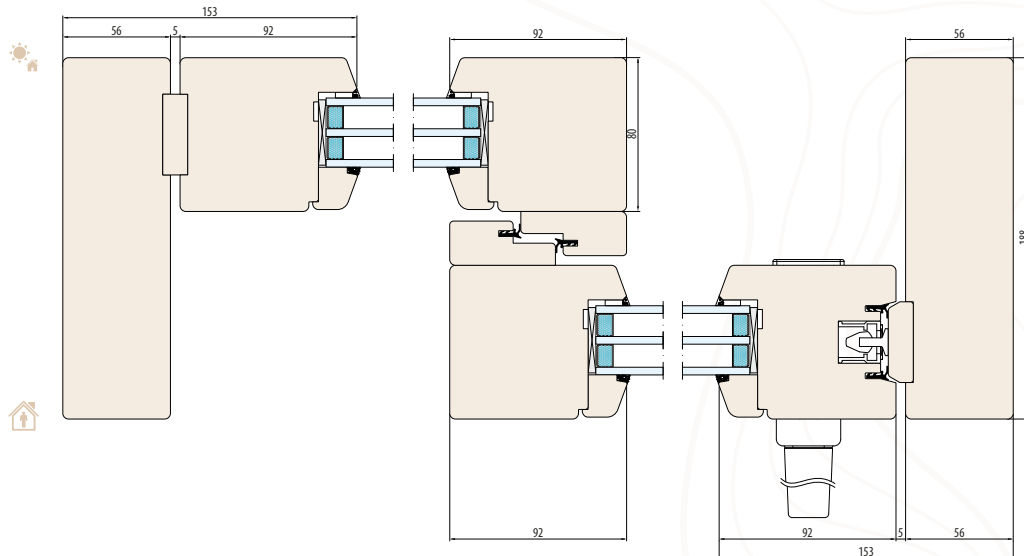
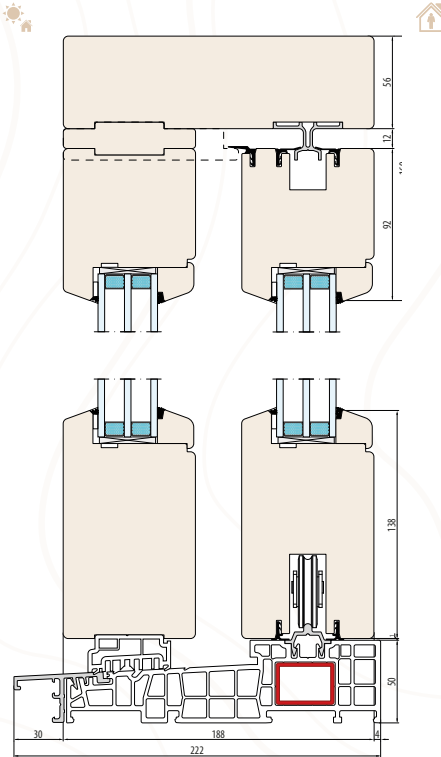



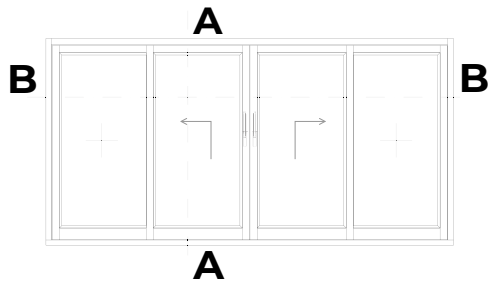

**NATURO 80 HST SYSTEM**  
(general dimensions) - threshold 24 mm - scheme 'C'

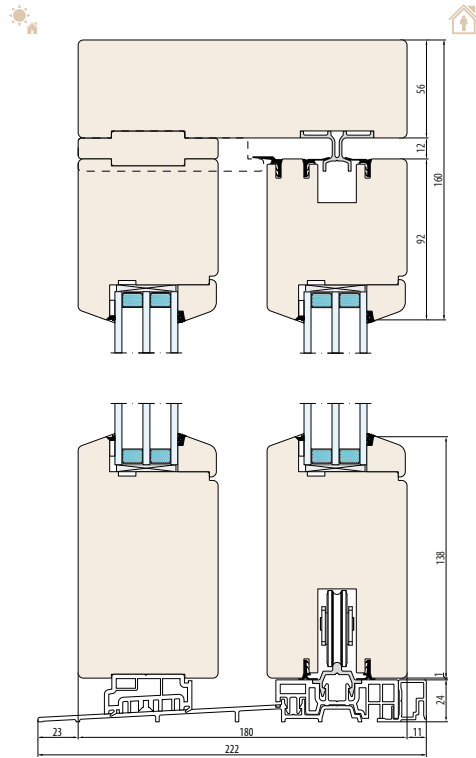

**NATURO 80 HST SYSTEM**  
(general dimensions) - threshold 50 mm - scheme 'C'

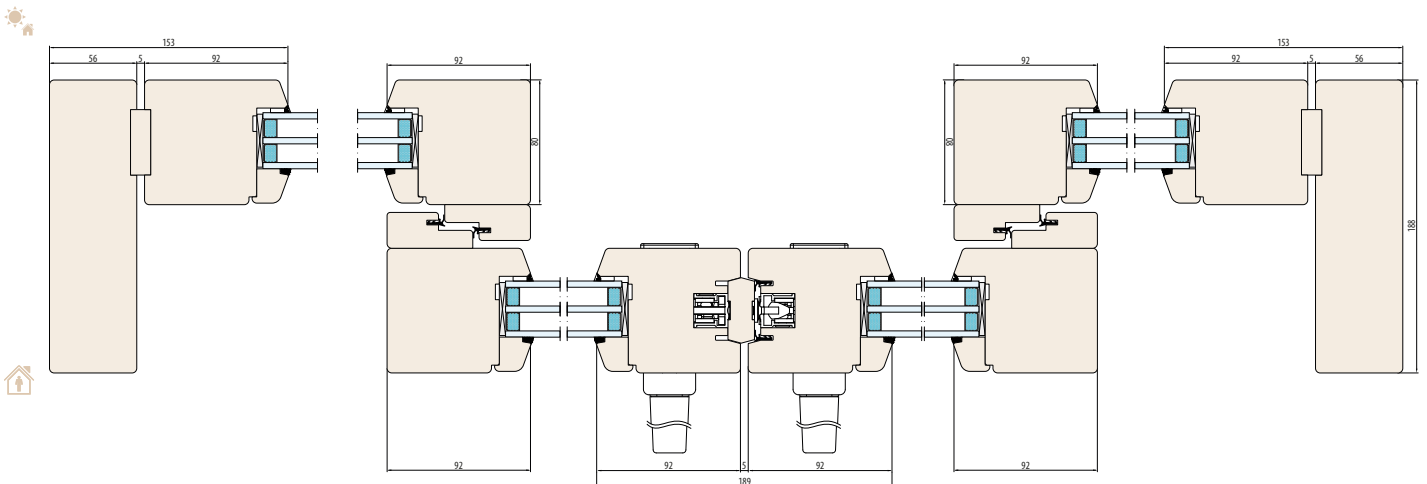
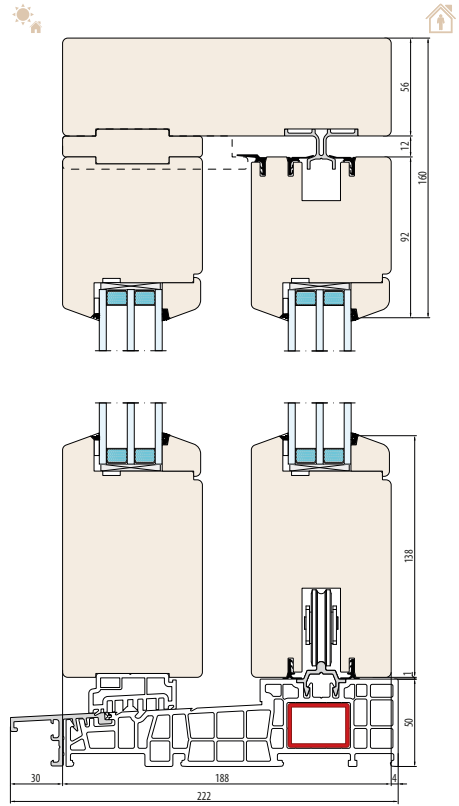

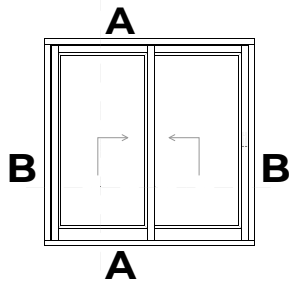

**NATURO 80 HST SYSTEM**  
(general dimensions) - threshold 24 mm - scheme 'D'

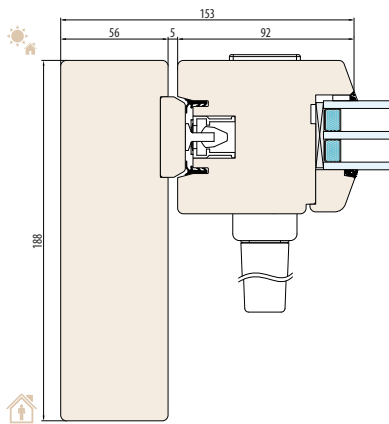
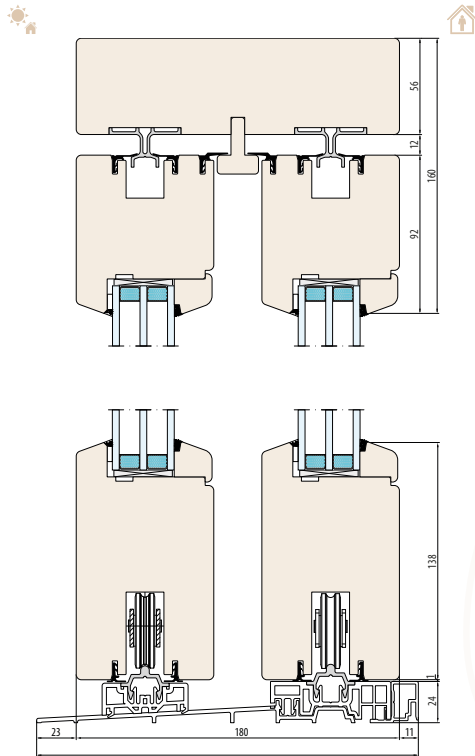

**NATURO 80 HST SYSTEM**  
(general dimensions) - threshold 50 mm - scheme 'D'

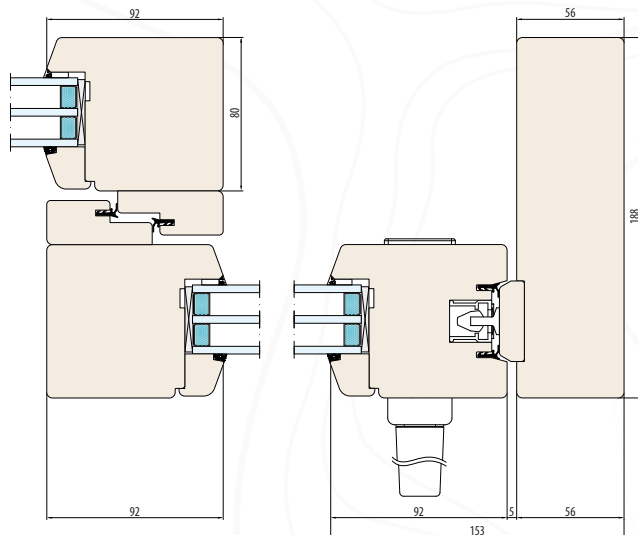
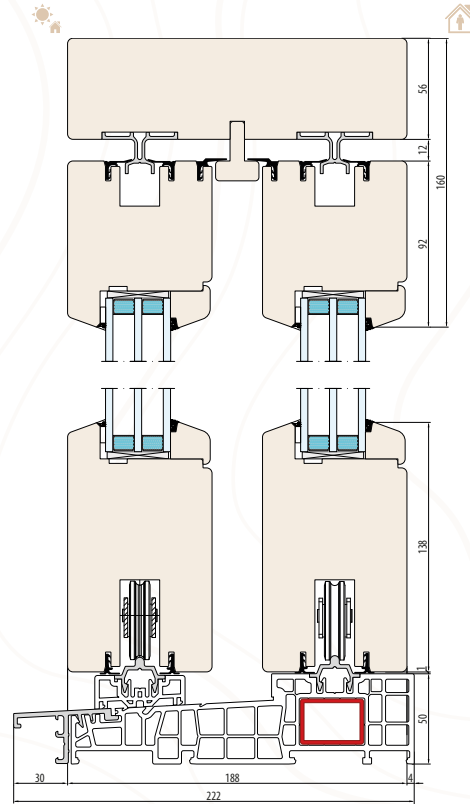

## MODEL WINDOWS AND DOORS

We offer joinery in arched and angled shapes, perfectly suited to buildings maintained in various styles. Investors are increasingly opting for unconventional shapes.

Arched windows lend a unique character to both the interior and the facade. They are often a decorative feature of classic residences, historic palaces, and buildings. On the other hand, angled windows are a proposition for modern buildings, which, with their form, reference more traditional objects.

We prioritize the latest technology, allowing us to meet individual customer expectations. With materials of the highest quality and state-of-the-art technology, the only limitation is imagination.

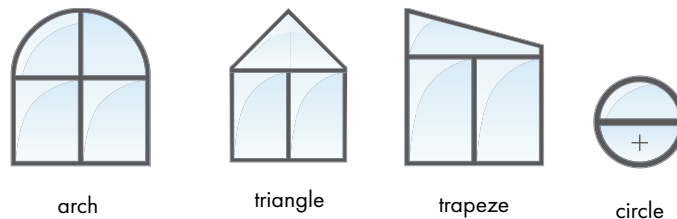

(+) fix window - permanently closed

## WOODEN DOORS

Wooden doors embody timeless elegance, fitting seamlessly into both modern and traditional settings.

Advanced technological processing of this natural, fully biodegradable material allows for the creation of durable, long-lasting, and warm solutions, which become the hallmark of any building. Customers can choose from a vast array of door panels from the WoodLine series and those based on EkoVitre glass, as well as veneered, milled doors.

the thickness of the panel and thus its acoustic and thermal insulation depend on the chosen wooden joinery system.





## MILLED PANELS

The panel designs are created through milling, allowing for a high level of creativity and the crafting of unique compositions tailored to the investor's expectations. By choosing our doors, you gain high-quality craftsmanship and aesthetics that perfectly match any style of interior design.



It's important to note that the panel is not made of solid wood, so slight differences in stain shades are possible.



## PATTERNS OF MILLED PANELS



Panel A



Panel B



Panel C



Panel D



Panel E



Panel F



Panel G



Panel H



Panel I



Panel J



Panel K



Panel L

## EXAMPLE MODELS OF MILLED PANELS





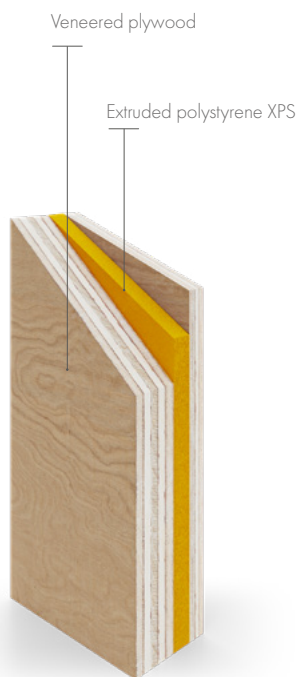



WoodLine

## DOOR WOODLINE PANELS

The WoodLine collection features over 140 unique door designs. It is also a harmonious blend of modern and traditional patterns, perfectly tailored to the preferences and needs of every customer.



It's important to note that the panel is not made of solid wood, so slight differences in stain shades are possible.



WoodLine 1



WoodLine 51



WoodLine 54



WoodLine 73



WoodLine 101



WoodLine 21



WoodLine 25



WoodLine 28



WoodLine 29



WoodLine 57

More panel designs available on the website and in the sales department.

Color options according to the stain palette and RAL color chart.

Possibility of using handles, access control, letter slots, peepholes.

As standard, panels without INOX overlays. The use of INOX overlays is possible after prior agreement with the technical department.





## EKOVITRE DOOR PANELS

EkoVitre panels with glazing offer unlimited possibilities for individual adaptation to each architectural project. They are constructed from two VSG glass panes, one of which features sandblasted patterns. EkoVitre panels are made from high-quality materials that guarantee an aesthetically pleasing appearance and durability.



It's important to note that the panel is not made of solid wood, so slight differences in stain shades are possible.



EkoVitre 01



EkoVitre 04



EkoVitre 06



EkoVitre 09



EkoVitre 15



EkoVitre 02



EkoVitre 05



EkoVitre 08



EkoVitre 10



EkoVitre 14

All models available upon request

We produce standard glazing in door panels from frosted glass.

Construction of the inserted glass panel: VSG 44.4, sandblasting according to the pattern, frame 18 mm, VSG 44.2 Plth. XN. Panel thickness 1 7/16", max. size 7ft 2in x3ft, min. size 5ft 5in x1ft 11in.







# ACCESSORIES



# PANES

The glazing installed in our windows takes the form of glass units, consisting of at least two glass panes. For achieving the best thermal performance, the space between the glass panes can be filled with noble gases: argon or krypton. We also apply coatings of metal oxides (thermo and one), which further reduce the thermal transmittance of the glazing.

The best glass units equipped with a so-called warm profile allow us to achieve a thermal transmittance coefficient  $U_g$  at the level of 0.05 Btu/h·ft<sup>2</sup>·F.

In addition to standard glass, we can also offer soundproof, safety, anti-burglary, ornamental, and solar control glass. The possibility of combining different types of glass and a smaller or larger number of panes allows us to achieve the appropriate parameters for each type of window and door in our offer.

---

Here's a comparison outlining the basic types of insulated glazing units along with a description of their functions:



## Double Pane Glazing Unit

A single-chamber double glazing unit composed of two glass panes. It is a standard for basic window and door systems.



## Triple Pane Glazing Unit

A double-chamber glazing unit enhance thermal comfort in the room. The separation of the space between the glass panes with an additional glass pane significantly reduces heat transfer.



## Soundproof

Insulated glazing units equipped with acoustic film provide an elevated level of noise reduction. Various glass thicknesses can effectively dampen sounds at specific frequencies.



## Safe

Laminated and/or tempered glass enhances safety. Tempered glass is stronger and breaks into blunt pieces, while laminated glass is harder to penetrate.



## Solar control

Solar control glass (selective, absorptive, or reflective) limits the flow of light and reduces the amount of heat energy entering interior spaces.

# DECORATIVE GLASS PANES

Decorative glass is an excellent choice for windows, doors and partition walls. Decorative glass panels are suitable for homes, offices, shops, hotels, and restaurants. Depending on the selected type or pattern, it can not only increase privacy, but also brighten the interior, making it optically more spacious, which is another advantage. In addition to standard matt acid-etched glass, we also offer glass in a wide range of colors, as well as ornamental glass available in many designs.



# MUNTIN BARS

Muntin bars give windows an elegant and distinctive character, and in some cases, they serve as an essential decorative element reminiscent of historical architectural styles.



## internal decorative muntin bars

Available colors of muntin bars:  
gold, matte gold, matte silver, white  
Size:  
8 mm



## internal decorative muntin bars\*

Available colors of muntin bars:  
RAL palette, veneer package  
Size:  
18, 26, 45 mm

\*The color of the muntin bar veneer may differ from the color of the wooden joinery



## Adhered with duplex

Available colors of muntin bars:  
RAL palette, veneer palette  
Duplex width:  
20, 24, 30 mm  
Widths of adhered muntin bars:  
22, 26, 32 mm

Available colors for duplex:  
colours of warm SWISSPACER Ultimate window frame,  
aluminum



## Structural

They are located within the window sash construction and divide the glass pane into sections. They are always wooden and match the color of the window sash.



# SPACER EDGES

## SWISSPACER ULTIMATE

In addition to the standard aluminum frame, we also offer one of the best warm edges available worldwide.

The warm SWISSPACER Ultimate frame eliminates thermal bridges and reduces the risk of water vapor condensation on the edges of the glass.

Frames are available in several colors from the RAL palette.

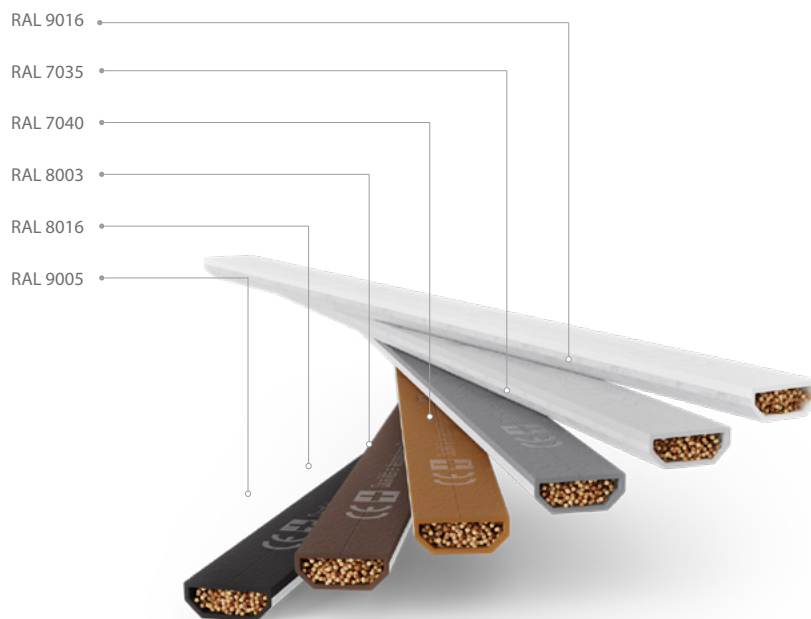

## FITTINGS

### Perimeter fittings in security classes RC1 and RC2

When choosing windows, it's worth paying attention to the class of anti-burglary protection.

RC1 and RC2 are resistance classes to burglary, defined by the European standard PN-EN 1627:2012. These labels indicate how effective the window technology is as a barrier against burglars, assessed based on very strict criteria.

RC2 windows should be installed where there is a risk of burglary. They are suitable for both high and low floors - areas where thieves can easily gain access, as well as for balcony and terrace doors. RC1 windows, on the other hand, have standard security features

**Wooden windows use Roto NX fittings. In wooden doors, GU Door Locks are used.**





# INTERIOR WINDOW SILLS

Wooden window sills are an optional addition that enhances the aesthetics of wooden joinery.

**Thickness:** 30 mm

**Depth:** from 80 mm to 1200 mm

**Types of wood:** solid pine, finger-jointed pine, spruce, oak, meranti

**Maximum length:** depends on the chosen type of wood

**Types of wood finish:** colours from the stain palette, RAL colours, clear varnish, clear impregnate, raw wood

Wooden window sills can have various corner shapes depending on the selected variant.



Pattern A



Pattern B



Pattern C



Pattern D



Pattern E



# DRIP CAP

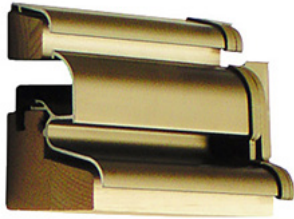

**Aluminium**

Installed as standard



**Wooden**

Optional installation

# DOOR ACCESSORIES

- Viewer
- Mail Slots
- Pet entrance

For more information, contact our sales representatives.



# HANDLES AND PULL HANDLES

The range of door handles includes both handles with standard backplates and separate ones (handle-insert). They are appreciated for their variety of designs, colors, handle functionality, and anti-burglary properties.

In addition to standard window handles, we offer handles with a button or locking key to prevent window opening. We also provide a wide selection of shapes and colors, making it easy to match them to the appearance of the selected joinery.

For external doors, we offer elegant and modern door handles. They can come in different shapes and lengths. We also offer solutions such as handle grips, which limit access to the building from the outside..

HANDLE FKS **1006**



HANDLE FAM **NEPTUN**



Pull handle **P1** Pull handle **P5** Pull handle **DP70** Pull handle **DP80**



There are many different designs of handles and grips available. For more information, please contact our sales representatives.

# TOP SECTION DESIGN



1G/Gt



1G



1G/G

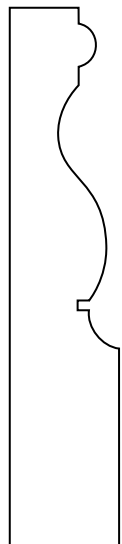

1D/Gt



1D



1D/Gt/K

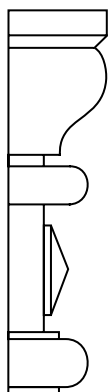

2G



2G/R

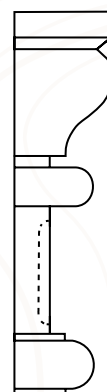

2G/2



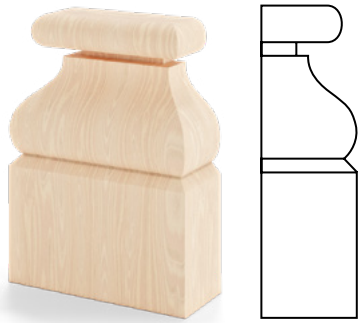

2D

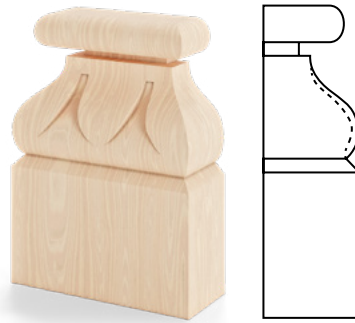

2D/R

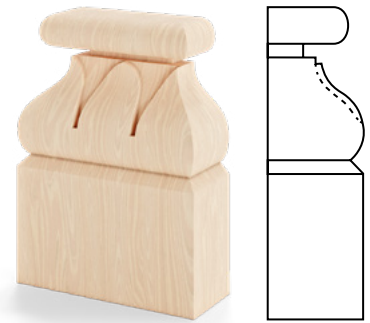

2D/2

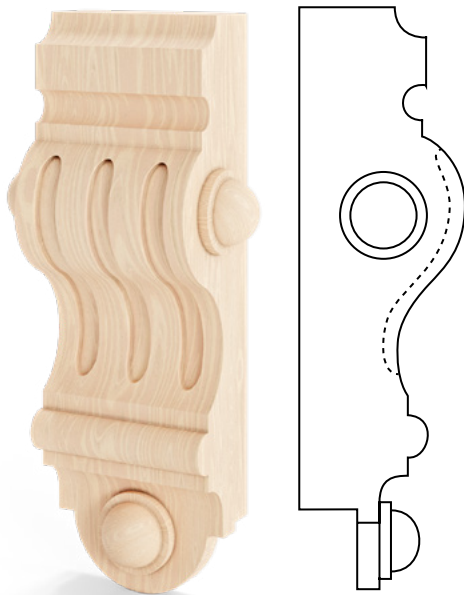

4G

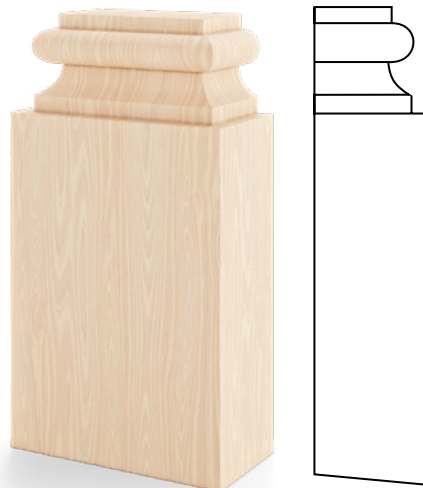

4D

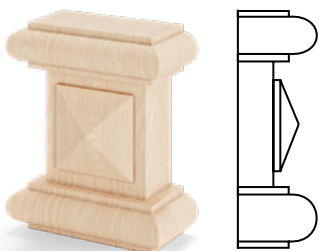

2S

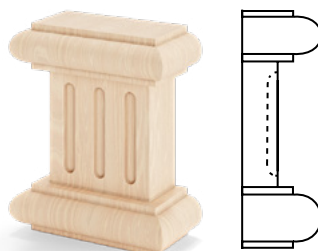

2S/2

We offer various styles of top sections tailored to selected systems. The catalog presents basic models; the full range is available from our sales representatives

# WOOD COLOR PALETTE **STANDARD**



RAW WOOD



CLEAR VARNISH

## RAL COLORS

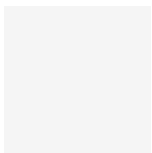

RAL 9016

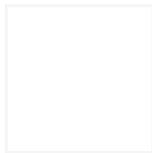

RAL 9010

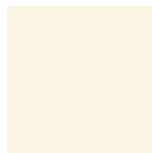

RAL 9001



RAL 8017



RAL 7035



RAL 7016



RAL 7021



RAL 9005



RAL 7039

## LAZUR COLORS

PINE



STONE PINE

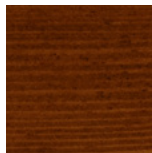

WALNUT

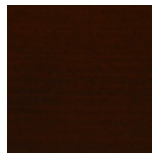

WENGE

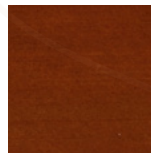

OAK

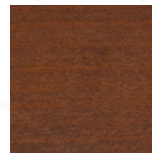

DARK CHESTNUT

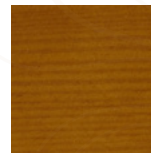

CYPRESS

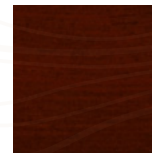

AFROMOSIA

MERANTI



STONE PINE

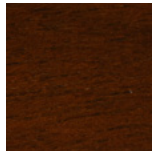

WALNUT

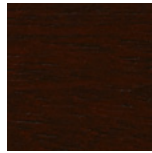

WENGE

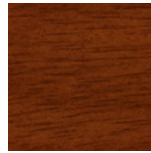

OAK

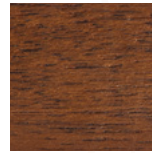

DARK CHESTNUT

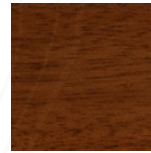

CYPRESS

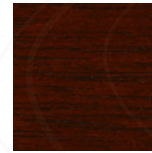

AFROMOSIA

The color scheme of the patterns should be treated only as an indicator, as there may be differences in the shades of individual colors depending on the type of wood, its natural color, and the thickness of the applied topcoat layer. The color samples are shown on pine and meranti wood. The presented colors may differ from the actual ones.



26.11.2024



Dual Action Windows LLC.    [info@dualactionwindows.com](mailto:info@dualactionwindows.com)    (321) 765-3355

The publication is not a commercial offer. It is not a basis for filing complaints.  
The presented photographs are illustrative and do not represent actual product images.

[www.dualactionwindows.com](http://www.dualactionwindows.com)